

THE MEADOWS PLANNED DEVELOPMENT PLAN NO.1 (FORMERLY THE MEADOWS PRELIMINARY P.D. SITE PLAN - THIRD AMENDMENT)

LOCATED IN THE SOUTHWEST QUARTER OF SECTION 27 AND THE
 NORTHWEST QUARTER OF SECTION 34, TOWNSHIP 7 SOUTH, RANGE 67
 WEST OF THE SIXTH PRINCIPAL MERIDIAN

SHEET 1 OF 2

LAND USE DATA:

NEIGHBORHOOD USE AREAS	USE AREA CATEGORIES	GROSS ACREAGE	PERCENT OF TOTAL ACREAGE	MAX. NUMBER OF DWELLING UNITS	MAX. NON-RESIDENTIAL FLOOR AREA/F.A.R.
B	R-SF (SINGLE FAMILY) (1)	31.7	1.2%	253	N/A
	COMMERCIAL-OFFICE-INDUSTRIAL (1)	43.3	1.6%	N/A	N/A
C	R-SF (SINGLE FAMILY) (1)	94.7	3.5%	493	N/A
D	R-SF (SINGLE FAMILY) (1)	388.5	14.4%	1467	N/A
E	R-SF (SINGLE FAMILY) (1)	281.1	10.4%	1470	N/A
SM	R-LMF (MULTI FAMILY) (1)	26.9	1.0%	323	N/A
TC	TC (TOWN CENTER) (1)	269.3	10.0%	3679	2.0
COI	C (COMMERCIAL)				
	O (OFFICE)				
	I (INDUSTRIAL) (1)	345.0		N/A	0.6
COI	COI - MEADOWS PDP NO.1	4.5		N/A	1.6
	SUBTOTAL	349.5	12.9%		
PLD	PUBLIC LAND DEDICATION (PARKS, SCHOOLS, MUNICIPAL) (1)	190.6		N/A	N/A
	PLD - MEADOWS PDP NO.1	0.9		N/A	N/A
	SUBTOTAL	191.5	7.1%		
OSD	OPEN SPACE (1)	1022.0		N/A	N/A
	OSD - MEADOWS PDP NO.1	1.6		N/A	N/A
TOTAL	SUBTOTAL	2700.1	100.0%	7685	N/A

(1) SHOWN FOR REFERENCE ONLY; NOT A PART OF THE MEADOWS PLANNED DEVELOPMENT PLAN NO. 1

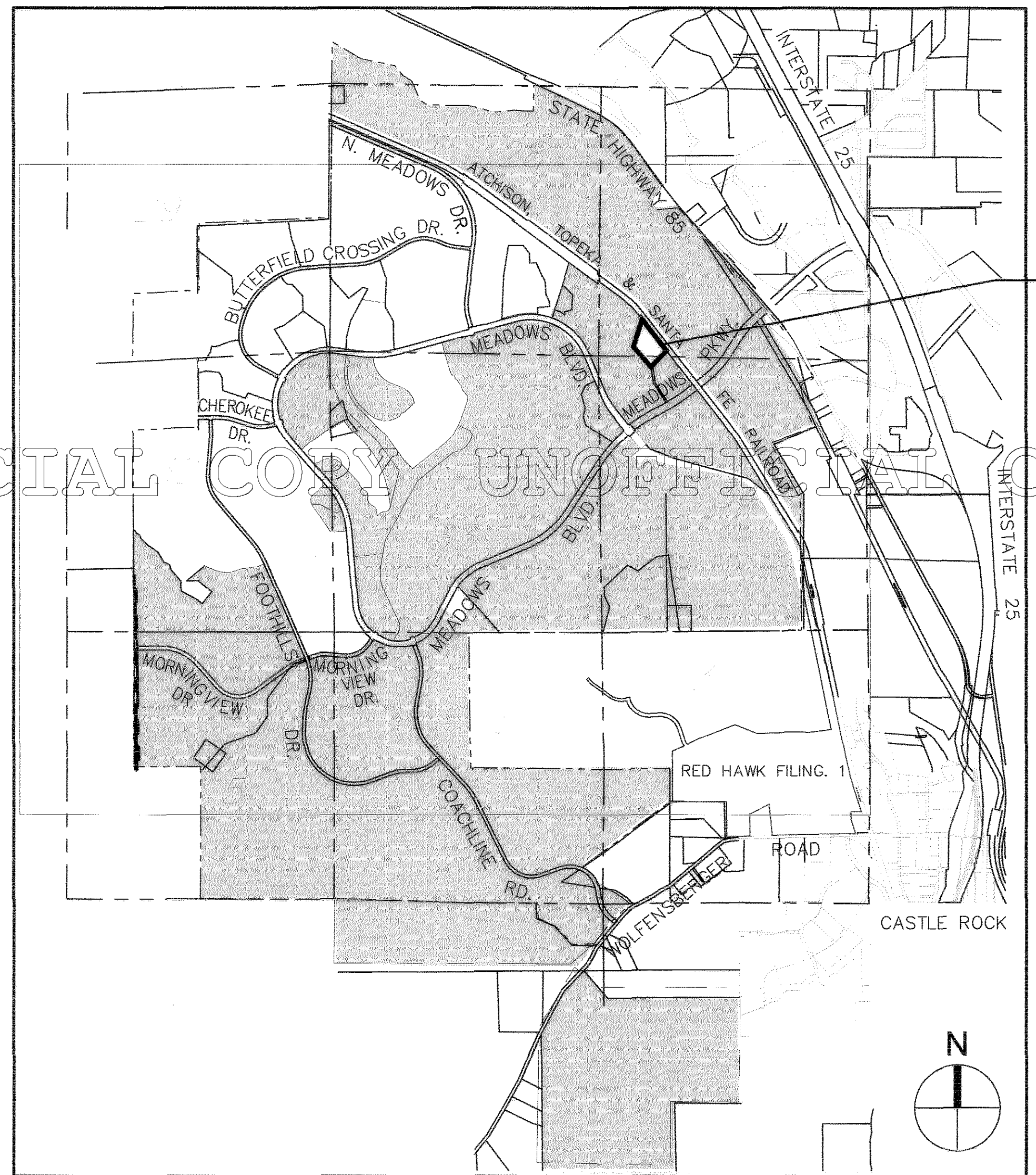

PROPERTY DESCRIPTION:

A PARCEL OF LAND BEING ALL OF PARCEL A AS DESCRIBED IN SPECIAL WARRANTY DEED RECORDED IN BOOK 1172 AT PAGE 5 IN THE OFFICE OF THE CLERK AND RECORDER OF THE COUNTY OF DOUGLAS, COLORADO, LOCATED IN THE SOUTHWEST QUARTER OF SECTION 27 AND THE NORTHWEST QUARTER OF SECTION 34, TOWNSHIP 7 SOUTH, RANGE 67 WEST OF THE SIXTH PRINCIPAL MERIDIAN, IN THE TOWN OF CASTLE ROCK, COUNTY OF DOUGLAS, STATE OF COLORADO, MORE PARTICULARLY DESCRIBED AS FOLLOWS:

BEGINNING AT THE MOST SOUTHERLY CORNER OF SAID PARCEL A WHENCE THE NORTHWESTERLY CORNER OF SAID PARCEL IS ASSUMED TO BEAR NORTH 38°13'10" WEST;

THENCE ALONG THE SOUTHWESTERLY, NORTHWESTERLY, NORTHEASTERLY AND SOUTHEASTERLY BOUNDARIES OF SAID PARCEL A THE FOLLOWING FOUR (4) COURSES:

- 1) ALONG THE NORTHEASTERLY RIGHT-OF-WAY LINE OF LIMELIGHT AVENUE, NORTH 38°13'10" WEST, A DISTANCE OF 505.27 FEET TO THE NORTHWESTERLY CORNER OF SAID PARCEL A ALSO BEING THE MOST SOUTHERLY CORNER OF LOT 2, THE MEADOWS FILING NO. 17, AREA NO. 1 A SUBDIVISION PLAT RECORDED AT RECEPTION NO. 2008005602, IN SAID RECORDS;
- 2) DEPARTING SAID NORTHEASTERLY RIGHT-OF-WAY LINE ALONG THE SOUTHEASTERLY BOUNDARY OF SAID LOT 2, NORTH 18°52'31" EAST, A DISTANCE OF 553.88 FEET TO A POINT ON THE SOUTHWESTERLY RIGHT-OF-WAY LINE OF ATCHISON, TOPEKA AND SANTA FE RAILROAD;
- 3) DEPARTING SAID SOUTHEASTERLY BOUNDARY ALONG SAID SOUTHWESTERLY RIGHT-OF-WAY LINE, SOUTH 38°13'08" EAST, A DISTANCE OF 806.17 FEET TO THE MOST NORTHERLY CORNER OF LOT 4, SAID MEADOWS FILING NO. 17, AREA NO. 1;
- 4) DEPARTING SAID SOUTHWESTERLY RIGHT-OF-WAY LINE ALONG THE NORTHWESTERLY BOUNDARY OF SAID LOT 4, SOUTH 51°46'50" WEST, A DISTANCE OF 465.01 FEET TO THE **POINT OF BEGINNING**.

CONTAINING AN AREA OF 7.000 ACRES, (304,920 SQUARE FEET), MORE OR LESS.

PURPOSE:

THE PURPOSE OF THIS PLANNED DEVELOPMENT PLAN IS TO REZONE SPECIFIC AREAS WITHIN THIS PARCEL FROM PLD TO COI, PLD AND OS, AND ESTABLISH F.A.R. FOR THE COI TRACTS REZONED IN THIS MEADOWS PDP NO.1 AT 1.6.

NOTES:

1. BY TOWN COUNCIL APPROVAL OF THIS THE MEADOWS PLANNED DEVELOPMENT PLAN NO. 1, THE PROPERTY DESCRIBED HEREIN IS HEREBY INCORPORATED INTO AND SUBJECTED TO THE MEADOWS PD ZONING REGULATIONS RECORDED AT RECEPTION NO. 2003102968, AS AMENDED FROM TIME TO TIME.
2. BY TOWN COUNCIL APPROVAL OF THIS THE MEADOWS PLANNED DEVELOPMENT PLAN NO. 1 AND THE OWNERSHIP CERTIFICATION HEREON, THE PROPERTY DESCRIBED HEREIN IS HEREBY INCORPORATED INTO AND SUBJECTED TO THE MEADOWS (FOURTH AMENDMENT) DEVELOPMENT AGREEMENT RECORDED AT RECEPTION NO. 2003102970, AS AMENDED FROM TIME TO TIME.

PREPARED BY

VOGEL & ASSOCIATES
 475 W. 12th Avenue - Suite E
 Denver, Colorado 80204-3688
 (303) 893-4288

PROPERTY OWNER
 CASTLE ROCK LAND COMPANY
 3033 E. 1ST AVENUE / SUITE 410
 DENVER, COLORADO 80206
 PHONE NUMBER: (303) 394-5500
 FAX NUMBER: (303) 394-5508
 CONTACT: JIM RILEY

LAND PLANNER
 VOGEL & ASSOCIATES
 475 W. 12TH AVE. SUITE E
 DENVER, COLORADO 80204
 PHONE NUMBER: (303) 893-4288
 FAX NUMBER: (303) 893-6792
 CONTACT: JEFF VOGEL

CIVIL ENGINEER
 C2C ENGINEERING, LLC.
 8551 S. REVERE PARKWAY, SUITE 140
 CENTENNIAL, COLORADO 80111
 PHONE: (720) 221-4520
 CONTACT: KURT LANG

SURVEYOR
 AZTEC CONSULTANTS INC.
 8000 SOUTH LINCOLN STREET, SUITE 201
 LITTLETON, COLORADO 80122
 PHONE: (303) 713-1898
 FAX: 303) 713-1897
 CONTACT: DEREK S. BROWN

SHEET INDEX	
COVER	1 OF 2
PLANNED DEVELOPMENT PLAN	2 OF 2

SHEET 1 OF 2 - COVER

Date: FEBRUARY 1, 2013
 Revision Date: FEBRUARY 19, 2013

THE MEADOWS PLANNED DEVELOPMENT PLAN NO.1
 PROJECT NO. PDP 13-0002

SURVEYOR'S STATEMENT

I, DEREK S. BROWN, PLS., A REGISTERED PROFESSIONAL LAND SURVEYOR REGISTERED IN THE STATE OF COLORADO, DO HEREBY ATTEST THAT THE LEGAL DESCRIPTION AS DESCRIBED HEREON WAS MADE UNDER MY DIRECT SUPERVISION.

DEREK S. BROWN PLS NO. 38064
 FOR AND ON BEHALF OF AZTEC CONSULTANTS, INC.

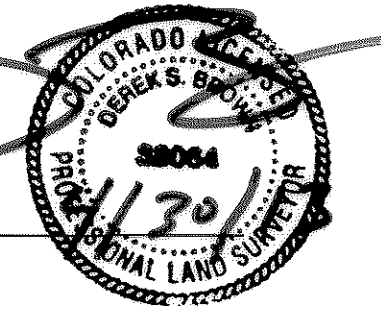

OWNERSHIP CERTIFICATION

THE UNDERSIGNED IS THE OWNER OF THE PROPERTY DESCRIBED HEREIN.

James M. Riley
 CASTLE ROCK DEVELOPMENT COMPANY, A COLORADO CORPORATION

STATE OF Colorado
 COUNTY OF Denver

THE FOREGOING INSTRUMENT WAS ACKNOWLEDGED BEFORE ME THIS 30th DAY OF April, A.D. 2013, BY JIM RILEY, AS PRESIDENT OF CASTLE ROCK DEVELOPMENT COMPANY, A COLORADO CORPORATION.
 MY COMMISSION EXPIRES: 3-7-16

Kelly Beach
 NOTARY PUBLIC
KELLY BEACH
 NOTARY PUBLIC, STATE OF COLORADO
 My Comm. Expires March 7, 2016

TITLE CERTIFICATION

I, *Sam Bennett*, AN AUTHORIZED REPRESENTATIVE OF *Land Title Guarantee Company*, A TITLE INSURANCE COMPANY LICENSED TO DO BUSINESS IN THE STATE OF COLORADO, HAVE MADE AN EXAMINATION OF THE PUBLIC RECORDS AND STATE THAT ALL OWNERS, MORTGAGEES AND LIENHOLDERS OF THE PROPERTY ARE LISTED IN THE CERTIFICATE OF OWNERSHIP AND LIENHOLDERS SUBORDINATION CERTIFICATE.

Sam Bennett
 AUTHORIZED REPRESENTATIVE
Land Title Guarantee Company
 TITLE INSURANCE COMPANY
 GUARANTEE

PLANNING COMMISSION RECOMMENDATION

THIS PLANNED DEVELOPMENT PLAN WAS RECOMMENDED FOR APPROVAL BY THE PLANNING COMMISSION OF THE TOWN OF CASTLE ROCK, COLORADO ON THE 14th DAY OF March, 2013.
Jodie Leo CHAIR DATE 5/9/13

ATTEST:
Paul Donahue DATE 5/14/13
 DIRECTOR OF DEVELOPMENT SERVICES

TOWN COUNCIL APPROVAL

THIS PLANNED DEVELOPMENT PLAN WAS APPROVED BY THE TOWN COUNCIL OF THE TOWN OF CASTLE ROCK, COLORADO, ON THE 14th DAY OF April, 2013.

Paul Donahue DATE 5/14/13
 MAYOR

ATTEST:
Galeyn Murr DATE 5-14-2013
 TOWN CLERK



DOUGLAS COUNTY CLERK AND RECORDER'S CERTIFICATE

THIS PLANNED DEVELOPMENT PLAN WAS FILED FOR RECORD IN THE OFFICE OF THE COUNTY CLERK AND RECORDER OF DOUGLAS COUNTY AT 1:47 pm ON THE 17th DAY OF May, 2013
 AT RECEPTION NO. 2013041128

DOUGLAS COUNTY CLERK AND RECORDER
 BY: *Amelisa Mankin*
 DEPUTY



THE MEADOWS PLANNED DEVELOPMENT PLAN NO.1 (FORMERLY THE MEADOWS PRELIMINARY P.D. SITE PLAN - THIRD AMENDMENT)

LOCATED IN THE SOUTHWEST QUARTER OF SECTION 27 AND THE
NORTHWEST QUARTER OF SECTION 34, TOWNSHIP 7 SOUTH, RANGE 67
WEST OF THE SIXTH PRINCIPAL MERIDIAN

SHEET 2 OF 2

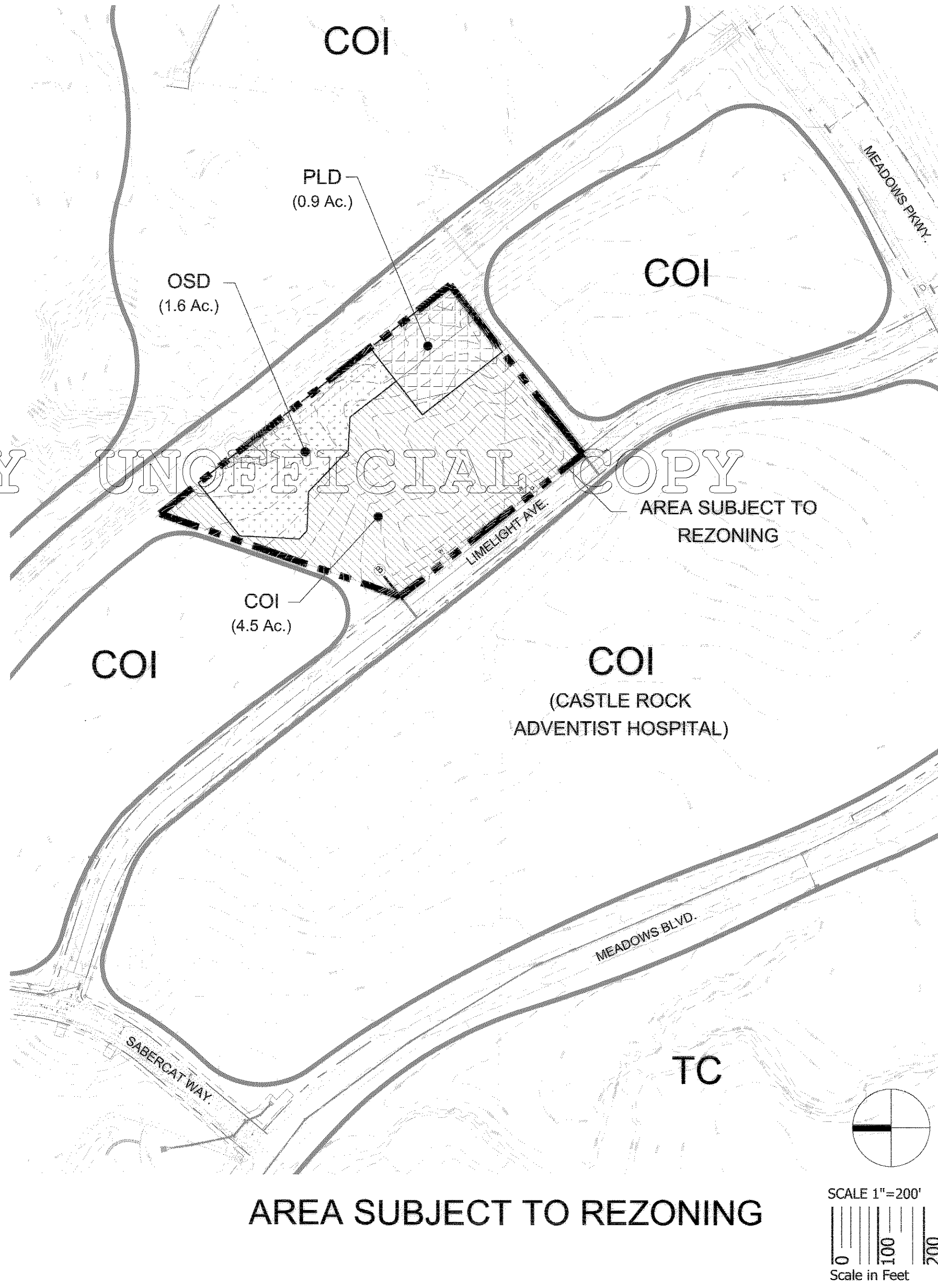
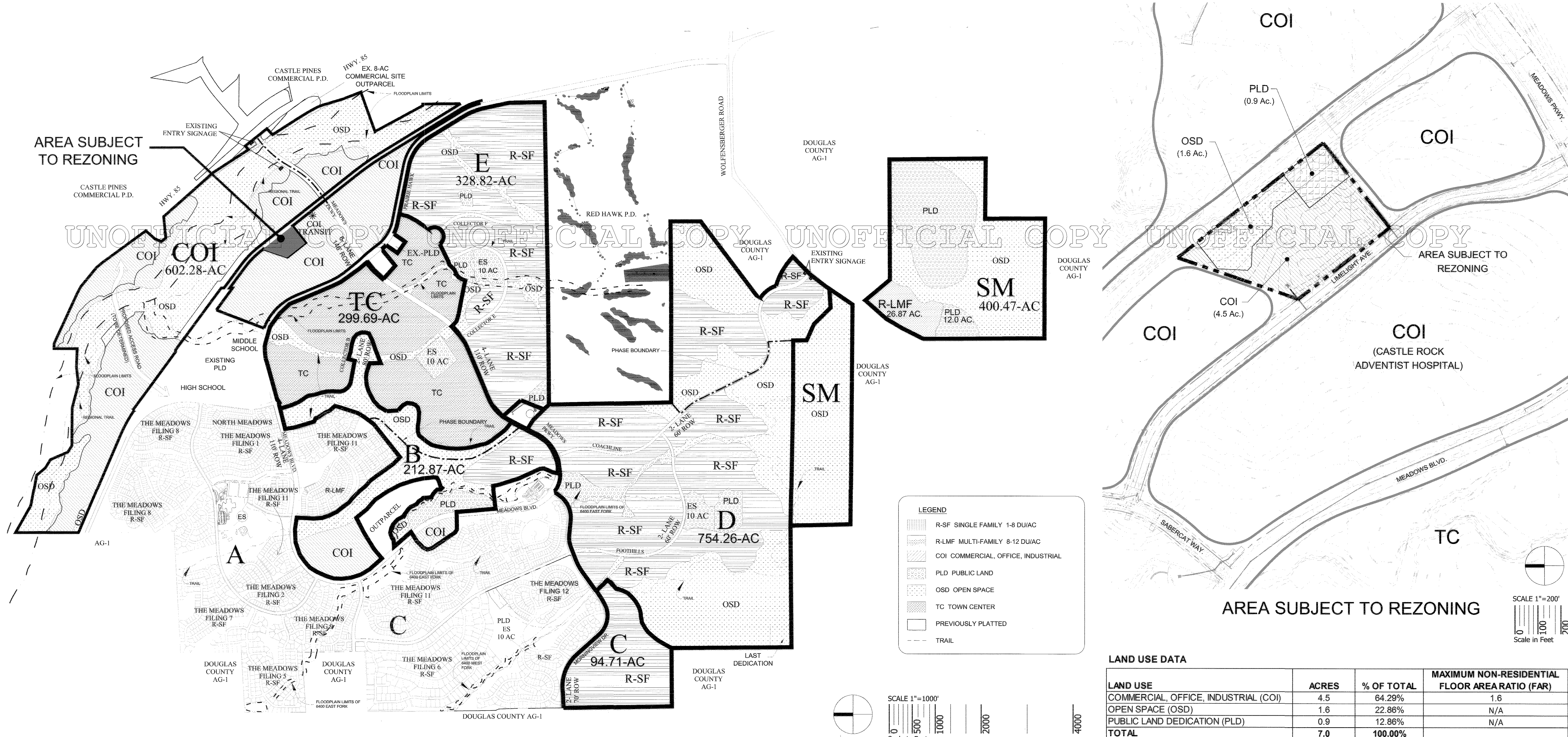

LAND USE DATA

LAND USE	ACRES	% OF TOTAL	MAXIMUM NON-RESIDENTIAL FLOOR AREA RATIO (FAR)
COMMERCIAL, OFFICE, INDUSTRIAL (COI)	4.5	64.29%	1.6
OPEN SPACE (OSD)	1.6	22.86%	N/A
PUBLIC LAND DEDICATION (PLD)	0.9	12.86%	N/A
TOTAL	7.0	100.00%	

NOTE:
SHOWN FOR REFERENCE ONLY; NOT A PART OF THIS MEADOWS PLANNED DEVELOPMENT PLAN NO.1.



SHEET 2 OF 2 - PLANNED DEVELOPMENT PLAN

Date: FEBRUARY 1, 2013
Revision Date: FEBRUARY 19, 2013

THE MEADOWS PLANNED DEVELOPMENT PLAN NO.1
PROJECT NO. PDP 13-0002

2003102968
07/10/2003 01:59 PM

ORDINANCE NO. 2003-18



AN ORDINANCE AMENDING THE TOWN'S ZONE DISTRICT MAP BY APPROVING THE MEADOWS PRELIMINARY P.D. SITE PLAN (MEADOWS FOURTH AMENDMENT), PD ZONING REGULATIONS, AND THE MEADOWS DEVELOPMENT AGREEMENT (THE MEADOWS FOURTH AMENDMENT); AND VESTING A SITE SPECIFIC DEVELOPMENT PLAN

WHEREAS, Castle Rock Development Company and Castle Rock Land Company (collectively, Owner) have requested an amendment to the existing PD planned development zoning of the parcel described in *Exhibit 1* (Property); and

WHEREAS, Owner has requested approval of the Meadows PD Zoning Regulations Fourth Amendment as described in the attached *Exhibit 2* as the same affect the Property (Zoning Regulations); and

WHEREAS, Owner has requested approval of "The Meadows Preliminary P.D. Site Plan, Meadows Fourth Amendment" (Site Plan); and

WHEREAS, public hearings on the Zoning Regulations and Site Plan have been held before the Planning Commission and Town Council in accordance with the applicable provisions of the Castle Rock Municipal Code; and

WHEREAS, Owner and Town have agreed to the terms of The Meadows (Fourth Amendment) Development Agreement (Development Agreement); and.

WHEREAS, the Town Council finds that the Site Plan shall be vested as a site specific development plan for certain prescribed periods of time specified in the Development Agreement, but in any event not extending beyond December 31, 2027, under authority of Town by Chapter 15.24 of the Castle Rock Municipal Code and C.R.S. §24-68-101, et seq.

NOW, THEREFORE, IT IS ORDAINED BY THE TOWN COUNCIL OF THE TOWN OF CASTLE ROCK, COLORADO AS FOLLOWS:

Section 1. Approval. The Zoning Regulations and Site Plan are approved for the Property.

Section 2. Development Agreement and Vesting. The Development Agreement is approved. The vesting of the Site Plan authorized under Article X of the Development Agreement is approved, which vests the Site Plan as a site specific development plan for an initial primary term ending on December 31, 2012, and a series of successive terms, upon the occurrence of certain

conditions attached to the renewal of each successive vesting period, as specifically provided in the Development Agreement, but in no event extending the vesting period beyond December 31, 2027. The notice of vesting of the Site Plan required under 15.24.100 of the Castle Rock Municipal Code shall be given within 14 days of the date of approval of this ordinance.

Section 3. Severability. If any clause, sentence, paragraph, or part of this ordinance or the application thereof to any person or circumstances shall for any reason be adjudged by a court of competent jurisdiction invalid, such judgment shall not affect the remaining provisions of this ordinance.

Section 4. Safety Clause. The Town Council finds and declares that this ordinance is promulgated and adopted for the public health, safety and welfare and this ordinance bears a rational relation to the legislative object sought to be obtained.

INTRODUCED this 24th day of March, 2003 for public comment, after publication in compliance with Section 2.02.100.C of the Castle Rock Municipal Code; and
PASSED, APPROVED AND ADOPTED this 14th day of April, 2003, by the Town Council of the Town of Castle Rock by a vote of 7 for and 0 against.

UNOFFICIAL COPY

ATTEST:

TOWN OF CASTLE ROCK

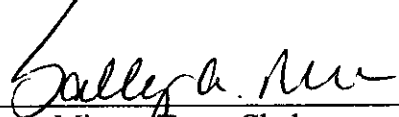
Sally A. Misare, Town Clerk

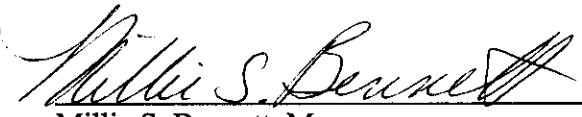
Millie S. Bennett, Mayor

Approved as to form:



Robert J. Slentz, Town Attorney

EXHIBIT 1

MEADOWS P.D. - PARCEL 1

A PARCEL OF LAND LOCATED IN SECTION 21, SECTION 27, SECTION 28, AND SECTION 34, TOWNSHIP 7 SOUTH, RANGE 67 WEST OF THE SIXTH PRINCIPAL MERIDIAN, TOWN OF CASTLE ROCK, COUNTY OF DOUGLAS, STATE OF COLORADO, MORE PARTICULARLY DESCRIBED AS FOLLOWS:

BEGINNING AT THE SOUTHWEST CORNER OF SAID SECTION 21; THENCE ALONG THE WEST LINE OF THE SW 1/4 OF SAID SECTION 21, NORTH 00°03'54" EAST, 818.87 FEET; THENCE SOUTH 60°22'56" EAST, 668.40 FEET; THENCE SOUTH 79°15'48" EAST, 672.68 FEET; THENCE SOUTH 40°30'26" EAST, 248.39 FEET; THENCE SOUTH 58°58'36" EAST, 210.95 FEET; THENCE SOUTH 23°14'24" EAST, 412.31 FEET; THENCE SOUTH 57°40'16" EAST, 166.43 FEET; THENCE SOUTH 89°42'27" EAST, 820.06 FEET; THENCE SOUTH 75°03'22" EAST, 528.87 FEET; THENCE NORTH 83°35'05" EAST, 382.10 FEET; THENCE SOUTH 87°31'45" EAST, 394.09 FEET TO A POINT ON THE EAST LINE OF THE WEST HALF OF THE NE 1/4 OF SAID SECTION 28; THENCE ALONG SAID EAST LINE OF THE WEST HALF OF THE NE 1/4 OF SAID SECTION 28, NORTH 00°11'49" EAST, 504.20 FEET TO THE NORTHEAST CORNER OF THE WEST HALF OF THE NE 1/4 OF SAID SECTION 28; THENCE ALONG THE NORTH LINE OF SAID NE 1/4, SOUTH 89°51'01" EAST, 109.11 FEET TO A POINT ON THE WESTERLY RIGHT-OF-WAY LINE OF THE DENVER & RIO GRANDE WESTERN RAILROAD; THENCE ALONG SAID RAILROAD RIGHT-OF-WAY THE FOLLOWING FIVE (5) COURSES:

- 1) SOUTH 65°14'51" EAST, 1192.05 FEET;
- 2) THENCE SOUTH 61°47'13" EAST, 177.62 FEET TO A POINT ON A NON-TANGENT CURVE;
- 3) THENCE 524.08 FEET ALONG THE ARC OF A CURVE TO THE RIGHT THROUGH A CENTRAL ANGLE OF 17°35'30", HAVING A RADIUS OF 1765.53 FEET AND A CHORD BEARING SOUTH 50°41'17" EAST, 539.95 FEET TO A NON-TANGENT LINE;
- 4) THENCE SOUTH 39°35'22" EAST, 177.62 FEET;
- 5) THENCE SOUTH 36°07'46" EAST, 1157.12 FEET;

THENCE SOUTH 41°24'30" WEST, 266.18 FEET; THENCE SOUTH 22°33'50" WEST, 154.62 FEET; THENCE SOUTH 40°45'13" EAST, 121.90 FEET; THENCE NORTH 84°30'37" EAST, 464.67 FEET TO A POINT ON A NON-TANGENT CURVE, LYING ON THE WESTERLY RIGHT-OF-WAY LINE OF SAID DENVER & RIO GRANDE WESTERN RAILROAD; THENCE CONTINUING ALONG SAID RIGHT-OF-WAY THE FOLLOWING ELEVEN (11) COURSES:

- 1) THENCE 84.14 FEET ALONG THE ARC OF A CURVE TO THE LEFT THROUGH A CENTRAL ANGLE OF 00°50'21", HAVING A RADIUS OF 5745.00 FEET AND A CHORD BEARING SOUTH 41°02'09" EAST, 84.14 FEET TO A POINT OF TANGENT;
- 2) THENCE SOUTH 41°28'45" EAST, 492.28 FEET TO A POINT OF CURVE;

EXHIBIT 1 (cont.)

3) THENCE 967.28 FEET ALONG THE ARC OF A CURVE TO THE RIGHT THROUGH A CENTRAL ANGLE OF $06^{\circ}47'10''$, HAVING A RADIUS OF 8166.82 FEET AND A CHORD BEARING SOUTH $36^{\circ}21'31''$ EAST, 966.71 FEET TO A POINT OF TANGENT;

4) THENCE SOUTH $32^{\circ}50'33''$ EAST, 1048.94 FEET TO A POINT ON THE NORTHWESTERLY RIGHT-OF-WAY OF MEADOWS PARKWAY AS DEDICATED BY THE PLAT OF MEADOWS PARKWAY PHASE 1, AS RECORDED AT RECEPTION NUMBER 8722230 OF THE DOUGLAS COUNTY RECORDS;

5) THENCE SOUTH $32^{\circ}50'33''$ EAST, 147.68 FEET TO A POINT ON THE SOUTHEASTERLY RIGHT-OF-WAY OF SAID MEADOWS PARKWAY;

6) THENCE SOUTH $32^{\circ}50'33''$ EAST, 14.97 FEET;

7) THENCE SOUTH $57^{\circ}09'27''$ WEST, 25.00 FEET;

8) THENCE SOUTH $32^{\circ}50'33''$ EAST, 854.20 FEET TO A POINT OF CURVE;

9) THENCE 1087.76 FEET ALONG THE ARC OF A CURVE TO THE RIGHT THROUGH A CENTRAL ANGLE OF $10^{\circ}58'21''$, HAVING A RADIUS OF 5680.00 FEET AND A CHORD BEARING SOUTH $27^{\circ}21'22''$ EAST, 1086.09 FEET TO A POINT OF TANGENT;

10) THENCE SOUTH $21^{\circ}52'11''$ EAST, 260.32 FEET TO A POINT OF CURVE;

11) THENCE 138.49 FEET ALONG THE ARC OF A CURVE TO THE LEFT THROUGH A CENTRAL ANGLE OF $01^{\circ}15'10''$, HAVING A RADIUS OF 6334.36 FEET AND A CHORD BEARING SOUTH $22^{\circ}29'46''$ EAST, 138.49 FEET TO A NON-TANGENT LINE;

THENCE SOUTH $70^{\circ}11'40''$ WEST, 911.41 FEET; THENCE SOUTH $28^{\circ}23'43''$ EAST, 1183.73 FEET TO A POINT ON THE SOUTH LINE OF THE NE 1/4 OF SAID SECTION 34; THENCE ALONG THE SOUTH LINE OF THE NE 1/4 OF SAID SECTION 34, SOUTH $89^{\circ}57'44''$ EAST, 34.23 FEET TO THE NORTHEAST CORNER OF THE WEST HALF OF THE SE 1/4 OF SAID SECTION 34; THENCE ALONG THE EAST LINE OF THE WEST HALF OF THE SE 1/4 OF SAID SECTION 34, SOUTH $00^{\circ}50'08''$ EAST, 828.87 FEET TO A POINT ON A NON-TANGENT CURVE LYING ON THE NORTHEASTERLY RIGHT-OF-WAY OF THE ATCHISON, TOPEKA & SANTA FE RAILROAD; THENCE ALONG SAID RAILROAD RIGHT-OF-WAY THE FOLLOWING FOURTEEN (14) COURSES:

1) 46.48 FEET ALONG THE ARC OF A CURVE TO THE LEFT THROUGH A CENTRAL ANGLE OF $01^{\circ}47'47''$, HAVING A RADIUS OF 1482.69 FEET AND A CHORD BEARING NORTH $30^{\circ}42'21''$ WEST, 46.48 FEET TO A POINT OF TANGENT;

2) THENCE NORTH $31^{\circ}36'15''$ WEST, 2035.83 FEET TO A POINT OF CURVE;

3) THENCE 667.28 FEET ALONG THE ARC OF A CURVE TO THE LEFT THROUGH A CENTRAL ANGLE OF $06^{\circ}36'54''$, HAVING A RADIUS OF 5779.65 FEET AND A CHORD BEARING NORTH $34^{\circ}54'42''$ WEST, 666.91 FEET TO A POINT OF TANGENT;

UNOFFICIAL COPY

EXHIBIT 1 (cont.)

- 4) THENCE NORTH 38°13'09" WEST, 2670.70 FEET TO A POINT OF CURVE;
- 5) THENCE 524.67 FEET ALONG THE ARC OF A CURVE TO THE LEFT THROUGH A CENTRAL ANGLE OF 15°20'14", HAVING A RADIUS OF 1960.04 FEET AND A CHORD BEARING NORTH 45°53'16" WEST, 523.11 FEET TO A POINT OF TANGENT;
- 6) THENCE NORTH 53°33'22" WEST, 630.36 FEET TO A POINT ON THE WEST LINE OF THE SW 1/4 OF SAID SECTION 27;
- 7) THENCE ALONG THE WEST LINE OF THE SW 1/4 OF SAID SECTION 27, NORTH 00°13'23" EAST, 61.96 FEET;
- 8) THENCE NORTH 53°33'22" WEST, 1676.03 FEET TO A POINT ON THE NORTH LINE OF THE SE 1/4 OF SAID SECTION 28;
- 9) THENCE ALONG THE NORTH LINE OF THE SE 1/4 OF SAID SECTION 28, NORTH 89°38'04" WEST, 42.45 FEET;
- 10) THENCE NORTH 53°33'22" WEST, 1471.44 FEET TO A POINT OF CURVE;
- 11) THENCE 95.03 FEET ALONG THE ARC OF A CURVE TO THE LEFT THROUGH A CENTRAL ANGLE OF 01°51'06", HAVING A RADIUS OF 2940.18 FEET AND A CHORD BEARING NORTH 54°28'55" WEST, 95.02 FEET TO A POINT ON THE WEST LINE OF THE NE 1/4 OF SAID SECTION 28;
- 12) THENCE ALONG THE WEST LINE OF THE NE 1/4 OF SAID SECTION 28, SOUTH 00°09'49" WEST, 30.37 FEET TO A POINT ON NON-TANGENT CURVE;
- 13) THENCE 594.80 FEET ALONG THE ARC OF A CURVE TO THE LEFT THROUGH A CENTRAL ANGLE OF 11°41'29", HAVING A RADIUS OF 2914.93 FEET AND A CHORD BEARING NORTH 60°54'49" WEST, 593.76 FEET TO A POINT OF TANGENT;
- 14) THENCE NORTH 66°45'33" WEST, 2329.04 FEET TO A POINT ON THE WEST LINE OF THE NW 1/4 OF SAID SECTION 28; THENCE ALONG THE WEST LINE OF THE NW 1/4 OF SAID SECTION 28, NORTH 00°03'42" EAST, 551.19 FEET TO THE POINT OF BEGINNING, CONTAINING 476.554 ACRES, MORE OR LESS.

EXCEPT THAT PORTION OF MEADOWS PARKWAY, CONTAINING 5.821 ACRES.

THE NET AREA FOR THE ABOVE DESCRIBED PARCEL CONTAINS 470.733 ACRES, MORE OR LESS.

BEARINGS ARE BASED ON THE WEST LINE OF THE NW 1/4 OF SECTION 28, TOWNSHIP 7 SOUTH, RANGE 67 WEST OF THE SIXTH PRINCIPAL MERIDIAN BEARING NORTH 00°03'42" EAST.

EXHIBIT 1 (cont.)

MEADOWS P.D. - PARCEL 2

02/03/03

A PARCEL OF LAND LOCATED IN THE SW 1/4 OF SECTION 27, THE SE 1/4 OF SECTION 28, THE NE 1/4 OF SECTION 33, AND A PORTION OF SECTION 34, TOWNSHIP 7 SOUTH, RANGE 67 WEST OF THE SIXTH PRINCIPAL MERIDIAN, TOWN OF CASTLE ROCK, COUNTY OF DOUGLAS, STATE OF COLORADO, MORE PARTICULARLY DESCRIBED AS FOLLOWS:

COMMENCING AT THE NORTH 1/4 CORNER OF SAID SECTION 34; THENCE SOUTH 47°26'39" WEST, 952.17 FEET TO A POINT ON THE SOUTHWESTERLY RIGHT- OF-WAY OF THE ATCHISON, TOPEKA & SANTA FE RAILROAD, AND THE SOUTHEASTERLY RIGHT- OF-WAY OF MEADOWS PARKWAY PHASE 1, AS RECORDED AT RECEPTION NUMBER 8722230 OF THE DOUGLAS COUNTY RECORDS, SAID POINT BEING THE TRUE POINT OF BEGINNING; THENCE ALONG SAID RAILROAD RIGHT-OF-WAY THE FOLLOWING FOUR (4) COURSES:

- 1) SOUTH 38°13'09" EAST, 807.72 FEET TO A POINT OF CURVE;
- 2) THENCE 655.74 FEET ALONG THE ARC OF A CURVE TO THE RIGHT THROUGH A CENTRAL ANGLE OF 06°36'54", HAVING A RADIUS OF 5679.65 FEET AND A CHORD BEARING SOUTH 34°54'42" EAST, 655.37 FEET TO POINT OF TANGENT;
- 3) THENCE SOUTH 31°36'15" EAST, 2035.82 FEET TO POINT OF CURVE;
- 4) THENCE 253.59 FEET ALONG THE ARC OF A CURVE TO THE RIGHT THROUGH A CENTRAL ANGLE OF 10°30'27", HAVING A RADIUS OF 1382.80 FEET AND A CHORD BEARING SOUTH 26°21'01" EAST, 253.24 FEET TO A POINT ON THE EAST LINE OF THE WEST HALF THE SE 1/4 OF SAID SECTION 34;

THENCE ALONG SAID EAST LINE, SOUTH 00°50'08" EAST, 191.54 FEET TO A POINT ON A NON-TANGENT CURVE ON THE NORTHEASTERLY RIGHT-OF-WAY OF SANTA FE DRIVE; THENCE ALONG SAID RIGHT-OF-WAY OF SANTA FE DRIVE THE FOLLOWING SIX (6) COURSES:

- 1) 474.52 FEET ALONG THE ARC OF A CURVE TO THE LEFT THROUGH A CENTRAL ANGLE OF 17°25'42", HAVING A RADIUS OF 1560.00 FEET AND A CHORD BEARING NORTH 22°53'24" WEST, 472.70 FEET TO A POINT OF TANGENT;
- 2) THENCE NORTH 31°36'15" WEST, 893.31 FEET TO A POINT OF CURVE;
- 3) THENCE 869.52 FEET ALONG THE ARC OF A CURVE TO THE LEFT THROUGH A CENTRAL ANGLE OF 47°00'00", HAVING A RADIUS OF 1060.00 FEET AND A CHORD BEARING NORTH 55°06'15" WEST, 845.35 FEET TO A POINT OF TANGENT;
- 4) THENCE NORTH 78°36'15" WEST, 1246.26 FEET TO A POINT OF CURVE;

EXHIBIT 1 (cont.)

5) THENCE 575.81 FEET ALONG THE ARC OF A CURVE TO THE RIGHT THROUGH A CENTRAL ANGLE OF 39°16'31", HAVING A RADIUS OF 840.00 FEET AND A CHORD BEARING NORTH 58°57'59" WEST, 564.60 FEET TO A POINT OF TANGENT;

6) THENCE NORTH 39°19'44" WEST, 27.57 FEET TO THE SOUTHEAST CORNER OF THE MEADOWS - FILING NO. 3, AS RECORDED AT RECEPTION NUMBER 8802433 OF THE DOUGLAS COUNTY RECORDS;

THENCE ALONG THE NORTHEASTERLY BOUNDARY OF SAID PLAT AND CONTINUING ALONG THE NORTHEASTERLY RIGHT-OF-WAY OF SAID SANTA FE DRIVE THE FOLLOWING TWO (2) COURSES:

1) NORTH 35°30'59" WEST, 75.61 FEET;

2) THENCE NORTH 39°19'50" WEST, 270.00 FEET TO A POINT ON THE SOUTHEASTERLY RIGHT-OF-WAY OF MEADOWS BOULEVARD AS RECORDED AT RECEPTION NUMBER 8727783 OF THE DOUGLAS COUNTY RECORDS;

THENCE ALONG SAID RIGHT-OF-WAY OF MEADOWS BOULEVARD THE FOLLOWING COURSES:

1) THENCE NORTH 36°45'47" WEST, 166.61 FEET TO A POINT ON A NON-TANGENT CURVE;

2) THENCE 30.88 FEET ALONG THE ARC OF A CURVE TO THE RIGHT THROUGH A CENTRAL ANGLE OF 88°27'55", HAVING A RADIUS OF 20.00 FEET AND A CHORD BEARING NORTH 83°33'48" WEST, 27.90 FEET TO A POINT OF TANGENT;

3) THENCE NORTH 39°19'50" WEST, 347.43 FEET TO A POINT OF CURVE;

4) THENCE 494.68 FEET ALONG THE ARC OF A CURVE TO THE RIGHT THROUGH A CENTRAL ANGLE OF 16°20'10", HAVING A RADIUS OF 1735.00 FEET AND A CHORD BEARING NORTH 31°09'45" WEST, 493.01 FEET TO A POINT OF TANGENT;

5) THENCE NORTH 22°59'40" WEST, 763.92 FEET TO A POINT OF CURVE;

6) THENCE 1008.83 FEET ALONG THE ARC OF A CURVE TO THE LEFT THROUGH A CENTRAL ANGLE OF 46°03'25", HAVING A RADIUS OF 1255.00 FEET AND A CHORD BEARING NORTH 46°01'23" WEST, 981.88 FEET;

THENCE ALONG THE EASTERLY BOUNDARY, EXTENDED, OF A PARCEL OF LAND DESCRIBED AT RECEPTION NUMBER 8819235, BOOK 809 AT PAGE 984, NORTH 20°57'03" EAST, 1109.30 FEET, MORE OR LESS, TO A POINT ON THE SOUTHWESTERLY RIGHT-OF-WAY OF THE ATCHISON, TOPEKA & SANTA FE RAILROAD; THENCE ALONG SAID

EXHIBIT 1 (cont.)

RAILROAD RIGHT-OF-WAY THE FOLLOWING FIVE (5) COURSES:

- 1) SOUTH 53°33'22" EAST, 596.95 FEET;
- 2) THENCE NORTH 00°13'23" EAST, 61.96 FEET;
- 3) THENCE SOUTH 53°33'22" EAST, 557.11 FEET TO A POINT OF CURVE;
- 4) THENCE 497.91 FEET ALONG THE ARC OF A CURVE TO THE RIGHT THROUGH A CENTRAL ANGLE OF 15°20'13", HAVING A RADIUS OF 1860.08 FEET AND A CHORD BEARING SOUTH 45°53'16" EAST, 496.42 FEET TO A POINT OF TANGENT;

5) THENCE SOUTH 38°13'09" EAST, 71.18 FEET TO THE NORTHERLY CORNER OF A PARCEL OF LAND DESCRIBED IN BOOK 1172 AT PAGE 5 OF THE DOUGLAS COUNTY RECORDS;

THENCE ALONG THE BOUNDARY OF SAID PARCEL THE FOLLOWING THREE (3) COURSES:

- 1) SOUTH 18°52'30" WEST, 553.84 FEET;
- 2) THENCE SOUTH 38°13'04" EAST, 505.27 FEET;
- 3) THENCE NORTH 51°46'51" EAST, 465.00 FEET TO A POINT ON SAID ATCHISON, TOPEKA & SANTA FE RAILROAD RIGHT-OF-WAY;

THENCE ALONG SAID RAILROAD RIGHT-OF-WAY, SOUTH 38°13'09" EAST, 985.66 FEET TO THE TRUE POINT OF BEGINNING, CONTAINING 135.277 ACRES, MORE OR LESS.

EXCEPT THAT PORTION OF MEADOWS PARKWAY, CONTAINING 4.943 ACRES.

THE NET AREA FOR THE ABOVE DESCRIBED PARCEL CONTAINS 130.334 ACRES, MORE OR LESS.

BEARINGS ARE BASED ON THE NORTH LINE OF THE NW 1/4 OF SECTION 34, TOWNSHIP 7 SOUTH, RANGE 67 WEST OF THE SIXTH PRINCIPAL MERIDIAN BEARING NORTH 89°35'47" WEST.

EXHIBIT 1 (cont.)

MEADOWS PD - PARCEL 3

02/03/03

A PARCEL OF LAND LOCATED IN THE SOUTH HALF OF SECTION 28, THE SE 1/4 OF SECTION 29, THE EAST HALF OF SECTION 32, SECTION 33, THE NW 1/4 OF SECTION 34, TOWNSHIP 7 SOUTH, RANGE 67 WEST OF THE SIXTH PRINCIPAL MERIDIAN, AND THE NW 1/4 OF SECTION 4, TOWNSHIP 8 SOUTH, RANGE 67 WEST, TOWN OF CASTLE ROCK, COUNTY OF DOUGLAS, STATE OF COLORADO, MORE PARTICULARLY DESCRIBED AS FOLLOWS:

COMMENCING AT THE NORTH 1/4 CORNER OF SAID SECTION 33; THENCE NORTH 57°18'52" WEST, 458.90 FEET TO THE NORTHEASTERLY CORNER OF THE MEADOWS FILING NO. 11 - PARCEL 3, SAID POINT LYING ON THE SOUTHERLY RIGHT-OF-WAY OF MEADOWS BOULEVARD, RECORDED AT RECEPTION NUMBER 8727783 OF THE DOUGLAS COUNTY RECORDS, SAID POINT BEING THE TRUE POINT OF BEGINNING; THENCE ALONG THE RIGHT-OF-WAY OF SAID MEADOWS BOULEVARD THE FOLLOWING TWENTY-NINE (29) COURSES:

- 1) NORTH 74°31'29" EAST, 340.28 FEET;
- 2) THENCE NORTH 81°22'03" EAST, 100.72 FEET;
- 3) THENCE NORTH 74°31'29" EAST, 103.08 FEET TO A POINT OF CURVE;
- 4) THENCE 31.42 FEET ALONG THE ARC OF A CURVE TO THE RIGHT THROUGH A CENTRAL ANGLE OF 90°00'00", HAVING A RADIUS OF 20.00 FEET AND A CHORD BEARING SOUTH 60°28'31" EAST, 28.28 FEET;
- 5) THENCE NORTH 74°31'29" EAST, 60.00 FEET;
- 6) THENCE NORTH 15°28'31" WEST, 12.00 FEET TO A POINT OF CURVE;
- 7) THENCE 31.42 FEET ALONG THE ARC OF A CURVE TO THE RIGHT THROUGH A CENTRAL ANGLE OF 90°00'00", HAVING A RADIUS OF 20.00 FEET AND A CHORD BEARING NORTH 29°31'29" EAST, 28.28 FEET TO A POINT OF TANGENT;
- 8) THENCE NORTH 74°31'29" EAST, 826.23 FEET TO A POINT OF CURVE;
- 9) THENCE 1648.30 FEET ALONG THE ARC OF A CURVE TO THE RIGHT THROUGH A CENTRAL ANGLE OF 82°28'51", HAVING A RADIUS OF 1145.00 FEET AND A CHORD BEARING SOUTH 64°14'06" EAST, 1509.61 FEET TO A POINT OF TANGENT;
- 10) THENCE SOUTH 22°59'40" EAST, 903.22 FEET TO A POINT OF CURVE;
- 11) THENCE 390.54 FEET ALONG THE ARC OF A CURVE TO THE LEFT THROUGH A CENTRAL ANGLE OF 16°20'10", HAVING A RADIUS OF 1369.75 FEET AND A CHORD BEARING SOUTH 31°09'45" EAST, 389.22 FEET TO A POINT OF TANGENT;

EXHIBIT 1 (cont.)

- 12) THENCE SOUTH 39°19'50" EAST, 72.59 FEET;
- 13) THENCE SOUTH 32°29'16" EAST, 100.72 FEET;
- 14) THENCE SOUTH 39°19'50" EAST, 187.32 FEET TO A POINT OF CURVE;
- 15) THENCE 30.77 FEET ALONG THE ARC OF A CURVE TO THE RIGHT THROUGH A CENTRAL ANGLE OF 88°08'47", HAVING A RADIUS OF 20.00 FEET AND A CHORD BEARING SOUTH 04°44'33" WEST, 27.82 FEET TO A POINT OF REVERSE CURVE;
- 16) THENCE 772.13 FEET ALONG THE ARC OF A CURVE TO THE LEFT THROUGH A CENTRAL ANGLE OF 16°00'29", HAVING A RADIUS OF 2763.59 FEET AND A CHORD BEARING SOUTH 40°48'43" WEST, 769.81 FEET TO A POINT OF TANGENT;
- 17) THENCE SOUTH 32°48'29" WEST, 1176.04 FEET TO A POINT OF CURVE;
- 18) THENCE 1013.46 FEET ALONG THE ARC OF A CURVE TO THE RIGHT THROUGH A CENTRAL ANGLE OF 34°15'28", HAVING A RADIUS OF 1695.00 FEET AND A CHORD BEARING SOUTH 49°56'13" WEST, 998.43 FEET TO A POINT OF TANGENT;
- 19) THENCE SOUTH 67°03'57" WEST, 1045.49 FEET TO A POINT OF CURVE;
- 20) THENCE 800.58 FEET ALONG THE ARC OF A CURVE TO THE LEFT THROUGH A CENTRAL ANGLE OF 39°42'51", HAVING A RADIUS OF 1155.00 FEET AND A CHORD BEARING SOUTH 47°12'31" WEST, 784.65 FEET TO A POINT OF TANGENT;
- 21) THENCE SOUTH 27°21'06" WEST, 643.87 FEET TO A POINT OF CURVE;
- 22) THENCE 334.86 FEET ALONG THE ARC OF A CURVE TO THE RIGHT THROUGH A CENTRAL ANGLE OF 24°08'01", HAVING A RADIUS OF 795.00 FEET AND A CHORD BEARING SOUTH 39°25'07" WEST, 332.39 FEET TO A POINT OF TANGENT;
- 23) THENCE SOUTH 62°00'32" WEST, 98.86 FEET TO A POINT OF CURVE;
- 24) THENCE 99.84 FEET ALONG THE ARC OF A CURVE TO THE RIGHT THROUGH A CENTRAL ANGLE OF 07°18'21", HAVING A RADIUS OF 783.00 FEET AND A CHORD BEARING SOUTH 62°16'09" WEST, 99.77 FEET TO A POINT OF COMPOUND CURVE;
- 25) THENCE 32.73 FEET ALONG THE ARC OF A CURVE TO THE RIGHT THROUGH A CENTRAL ANGLE OF 93°45'26", HAVING A RADIUS OF 20.00 FEET AND A CHORD BEARING NORTH 67°11'57" WEST, 29.20 FEET TO A NON-TANGENT LINE;
- 26) THENCE SOUTH 69°40'46" WEST, 60.00 FEET;
- 27) THENCE SOUTH 20°19'14" EAST, 12.03 FEET TO A POINT OF CURVE;
- 28) THENCE 32.71 FEET ALONG THE ARC OF A CURVE TO THE RIGHT THROUGH A

EXHIBIT 1 (cont.)

CENTRAL ANGLE OF $93^{\circ}41'57''$, HAVING A RADIUS OF 20.00 FEET AND A CHORD BEARING SOUTH $26^{\circ}31'45''$ WEST, 29.18 FEET TO A POINT OF COMPOUND CURVE;

29) THENCE 331.75 FEET ALONG THE ARC OF A CURVE TO THE RIGHT THROUGH A CENTRAL ANGLE OF $23^{\circ}54'33''$, HAVING A RADIUS OF 795.00 FEET AND A CHORD BEARING SOUTH $85^{\circ}19'59''$ WEST, 329.35 FEET;

THENCE DEPARTING SAID RIGHT-OF-WAY LINE, NORTH $30^{\circ}48'07''$ EAST, 182.90 FEET TO A POINT OF CURVE; THENCE 242.83 FEET ALONG THE ARC OF A CURVE TO THE LEFT THROUGH A CENTRAL ANGLE OF $56^{\circ}25'51''$, HAVING A RADIUS OF 246.56 FEET AND A CHORD BEARING NORTH $02^{\circ}35'12''$ EAST, 233.14 FEET; THENCE NORTH $25^{\circ}26'32''$ WEST, 637.17 FEET TO A POINT OF CURVE; THENCE 391.86 FEET ALONG THE ARC OF A CURVE TO THE RIGHT THROUGH A CENTRAL ANGLE OF $26^{\circ}24'49''$, HAVING A RADIUS OF 850.00 FEET AND A CHORD BEARING NORTH $12^{\circ}14'07''$ WEST, 388.39 FEET; THENCE SOUTH $83^{\circ}09'15''$ WEST, 490.55 FEET TO THE EASTERLY RIGHT-OF-WAY LINE OF SAID MEADOWS BOULEVARD; THENCE NORTH $04^{\circ}50'45''$ WEST, ALONG SAID RIGHT-OF-WAY LINE, 852.33 FEET; THENCE DEPARTING SAID RIGHT-OF-WAY LINE, SOUTH $89^{\circ}24'06''$ WEST, 427.13 FEET; THENCE NORTH $34^{\circ}08'42''$ WEST, 666.38 FEET; THENCE NORTH $21^{\circ}00'53''$ WEST, 32.56 FEET; THENCE NORTH $07^{\circ}11'15''$ WEST, 49.47 FEET, THENCE NORTH $11^{\circ}01'33''$ EAST, 48.32 FEET; THENCE NORTH $32^{\circ}08'52''$ EAST, 49.41 FEET; THENCE NORTH $47^{\circ}44'23''$ EAST, 56.72 FEET; THENCE NORTH $48^{\circ}35'13''$ EAST, 381.97 FEET TO THE EASTERLY RIGHT-OF-WAY LINE OF SAID MEADOWS BOULEVARD; THENCE ALONG SAID RIGHT-OF-WAY LINE NORTH $41^{\circ}24'47''$ WEST, 451.51 FEET; THENCE DEPARTING SAID RIGHT-OF-WAY LINE, NORTH $75^{\circ}44'49''$ EAST, 66.74 FEET TO A POINT OF CURVE; THENCE 51.12 FEET ALONG THE ARC OF A CURVE TO THE LEFT THROUGH A CENTRAL ANGLE OF $09^{\circ}45'48''$, HAVING A RADIUS OF 300.00 FEET AND A CHORD BEARING NORTH $70^{\circ}51'55''$ EAST, 51.06 FEET TO A POINT OF TANGENT; THENCE NORTH $65^{\circ}59'01''$ EAST, 70.63 FEET TO A POINT OF CURVE; THENCE 402.75 FEET ALONG THE ARC OF A CURVE TO THE RIGHT THROUGH A CENTRAL ANGLE OF $71^{\circ}00'11''$, HAVING A RADIUS OF 325.00 FEET AND A CHORD BEARING SOUTH $78^{\circ}30'53''$ EAST, 377.47 FEET TO A POINT OF TANGENT; THENCE SOUTH $43^{\circ}00'48''$ EAST, 471.39 FEET TO A POINT OF CURVE; THENCE 38.69 FEET ALONG THE ARC OF A CURVE TO THE RIGHT THROUGH A CENTRAL ANGLE OF $22^{\circ}10'07''$, HAVING A RADIUS OF 100.00 FEET AND A CHORD BEARING SOUTH $31^{\circ}55'44''$ EAST, 38.45 FEET TO A POINT OF TANGENT; THENCE SOUTH $20^{\circ}50'41''$ EAST, 59.91 FEET TO A POINT OF CURVE; THENCE 56.85 FEET ALONG THE ARC OF A CURVE TO THE LEFT THROUGH A CENTRAL ANGLE OF $32^{\circ}34'16''$, HAVING A RADIUS OF 100.00 FEET AND A CHORD BEARING SOUTH $37^{\circ}07'49''$ EAST, 56.08 FEET TO A POINT OF TANGENT; THENCE SOUTH $53^{\circ}24'57''$ EAST, 108.93 FEET TO A POINT OF CURVE; THENCE 69.92 FEET ALONG THE ARC OF A CURVE TO THE RIGHT THROUGH A CENTRAL ANGLE OF $53^{\circ}24'57''$, HAVING A RADIUS OF 75.00 FEET AND A CHORD BEARING SOUTH $26^{\circ}42'29''$ EAST, 67.42 FEET TO A POINT OF TANGENT; THENCE SOUTH $00^{\circ}00'00''$ WEST, 103.58 FEET TO A POINT OF CURVE; THENCE 101.95 FEET ALONG THE ARC OF A CURVE TO THE LEFT THROUGH A CENTRAL ANGLE OF $58^{\circ}24'50''$, HAVING A RADIUS OF 100.00 FEET AND A CHORD BEARING SOUTH $29^{\circ}12'25''$ EAST, 97.59 FEET TO A POINT OF TANGENT; THENCE SOUTH $58^{\circ}24'50''$ EAST, 99.07 FEET TO A POINT OF CURVE; THENCE 93.27 FEET ALONG THE ARC OF A CURVE TO THE RIGHT THROUGH A CENTRAL ANGLE OF

EXHIBIT 1 (cont.)

53°26'24", HAVING A RADIUS OF 100.00 FEET AND A CHORD BEARING SOUTH 31°41'38" EAST, 89.93 FEET TO A POINT OF TANGENT; THENCE SOUTH 04°58'26" EAST, 69.51 FEET TO A POINT OF CURVE; THENCE 14.16 FEET ALONG THE ARC OF A CURVE TO THE LEFT THROUGH A CENTRAL ANGLE OF 32°27'17", HAVING A RADIUS OF 25.00 FEET AND A CHORD BEARING SOUTH 21°12'04" EAST, 13.97 FEET TO A POINT OF TANGENT; THENCE SOUTH 37°25'43" EAST, 25.21 FEET; THENCE NORTH 36°06'05" EAST, 52.43 FEET TO A POINT OF CURVE; THENCE 76.56 FEET ALONG THE ARC OF A CURVE TO THE RIGHT THROUGH A CENTRAL ANGLE OF 48°44'27", HAVING A RADIUS OF 90.00 FEET, AND A CHORD BEARING NORTH 60°28'18" EAST, 74.27 FEET TO A POINT OF TANGENT; THENCE NORTH 84°50'32" EAST, 46.66 FEET; THENCE NORTH 79°15'12" EAST, 35.83 FEET TO A POINT OF CURVE; THENCE 94.28 FEET ALONG THE ARC OF A CURVE TO THE LEFT THROUGH A CENTRAL ANGLE OF 77°10'07", HAVING A RADIUS OF 70.00 FEET AND A CHORD BEARING NORTH 40°40'09" EAST, 87.32 FEET TO A POINT OF TANGENT; THENCE NORTH 02°05'05" EAST, 63.45 FEET; THENCE NORTH 05°50'13" WEST, 72.12 FEET; THENCE NORTH 09°10'52" WEST, 188.92 FEET; THENCE NORTH 14°29'33" WEST, 210.51 FEET TO A POINT OF CURVE; THENCE 1171.36 FEET ALONG THE ARC OF A CURVE TO THE LEFT THROUGH A CENTRAL ANGLE OF 36°51'24", HAVING A RADIUS OF 1820.93 FEET AND A CHORD BEARING NORTH 32°54'36" WEST, 1151.27 FEET TO A POINT OF REVERSE CURVE; THENCE 65.32 FEET ALONG THE ARC OF A CURVE TO THE RIGHT THROUGH A CENTRAL ANGLE OF 12°27'50", HAVING A RADIUS OF 300.27 FEET AND A CHORD BEARING NORTH 45°05'44" WEST, 65.19 FEET TO A POINT OF TANGENT; THENCE NORTH 38°51'29" WEST, 223.35 FEET; THENCE SOUTH 68°08'43" WEST, 112.84 FEET; THENCE SOUTH 57°55'08" WEST, 693.10 FEET; THENCE SOUTH 48°35'13" WEST, 211.87 FEET TO A POINT ON THE EASTERLY RIGHT- OF-WAY OF SAID MEADOWS BOULEVARD; THENCE ALONG SAID RIGHT-OF-WAY THE FOLLOWING EIGHTEEN (18) COURSES:

- 1) NORTH 41°24'47" WEST, 318.21 FEET TO A POINT OF CURVE;
- 2) THENCE 103.04 FEET ALONG THE ARC OF A CURVE TO THE RIGHT THROUGH A CENTRAL ANGLE OF 05°56'01", HAVING A RADIUS OF 995.00 FEET AND A CHORD BEARING NORTH 38°26'46" WEST, 103.00 FEET TO A POINT OF TANGENT;
- 3) THENCE NORTH 25°40'58" WEST, 99.10 FEET TO A POINT OF CURVE;
- 4) THENCE 100.44 FEET ALONG THE ARC OF A CURVE TO THE RIGHT THROUGH A CENTRAL ANGLE OF 05°51'16", HAVING A RADIUS OF 983.00 FEET AND A CHORD BEARING NORTH 26°51'03" WEST, 100.40 FEET TO A POINT OF COMPOUND CURVE;
- 5) THENCE 32.45 FEET ALONG THE ARC OF A CURVE TO THE RIGHT THROUGH A CENTRAL ANGLE OF 92°58'34", HAVING A RADIUS OF 20.00 FEET AND A CHORD BEARING NORTH 22°33'52" EAST, 29.01 FEET;
- 6) THENCE NORTH 20°56'50" WEST, 60.00 FEET;
- 7) THENCE SOUTH 69°03'10" WEST, 12.02 FEET TO A POINT OF CURVE;
- 8) THENCE 32.44 FEET ALONG THE ARC OF A CURVE TO THE RIGHT THROUGH A

EXHIBIT 1 (cont.)

CENTRAL ANGLE OF $92^{\circ}56'22''$, HAVING A RADIUS OF 20.00 FEET AND A CHORD BEARING NORTH $64^{\circ}28'39''$ WEST, 29.00 FEET TO A POINT OF COMPOUND CURVE;

9) THENCE 549.27 FEET ALONG THE ARC OF A CURVE TO THE RIGHT THROUGH A CENTRAL ANGLE OF $31^{\circ}37'45''$, HAVING A RADIUS OF 995.00 FEET AND A CHORD BEARING NORTH $02^{\circ}11'35''$ WEST, 542.32 FEET TO A POINT OF TANGENT;

10) THENCE NORTH $23^{\circ}24'47''$ EAST, 99.23 FEET TO A POINT OF CURVE;

11) THENCE 100.48 FEET ALONG THE ARC OF A CURVE TO THE RIGHT THROUGH A CENTRAL ANGLE OF $05^{\circ}51'24''$, HAVING A RADIUS OF 983.00 FEET AND A CHORD BEARING NORTH $22^{\circ}15'32''$ EAST, 100.44 FEET TO A POINT OF COMPOUND CURVE;

12) THENCE 32.45 FEET ALONG THE ARC OF A CURVE TO THE RIGHT THROUGH A CENTRAL ANGLE OF $92^{\circ}58'34''$, HAVING A RADIUS OF 20.00 FEET AND A CHORD BEARING NORTH $71^{\circ}40'31''$ EAST, 29.01 FEET;

13) THENCE NORTH $28^{\circ}09'48''$ EAST, 60.00 FEET;

14) THENCE NORTH $61^{\circ}50'12''$ WEST, 12.02 FEET TO A POINT OF CURVE;

15) THENCE 32.44 FEET ALONG THE ARC OF A CURVE TO THE RIGHT THROUGH A CENTRAL ANGLE OF $92^{\circ}56'22''$, HAVING A RADIUS OF 20.00 FEET AND A CHORD BEARING NORTH $15^{\circ}22'01''$ WEST, 29.00 FEET TO A POINT OF COMPOUND CURVE;

16) THENCE 1153.48 FEET ALONG THE ARC OF A CURVE TO THE RIGHT THROUGH A CENTRAL ANGLE OF $66^{\circ}25'18''$, HAVING A RADIUS OF 995.00 FEET AND A CHORD BEARING NORTH $64^{\circ}18'49''$ EAST, 1089.97 FEET TO A POINT OF TANGENT;

17) THENCE SOUTH $82^{\circ}28'31''$ EAST, 198.67 FEET TO THE WESTERLY RIGHT-OF-WAY OF SPRING MEADOWS CIRCLE;

THENCE ALONG SAID WESTERLY RIGHT-OF-WAY THE FOLLOWING FIVE (5) COURSES:

1) 43.98 FEET ALONG THE ARC OF A CURVE TO THE RIGHT THROUGH A CENTRAL ANGLE OF $90^{\circ}00'00''$, HAVING A RADIUS OF 28.00 FEET AND A CHORD BEARING SOUTH $37^{\circ}38'31''$ EAST, 39.60 FEET;

2) THENCE SOUTH $07^{\circ}31'29''$ WEST, 65.00 FEET;

3) THENCE SOUTH $06^{\circ}19'21''$ WEST, 153.47 FEET TO A POINT OF CURVE;

4) THENCE 907.20 FEET ALONG THE ARC OF A CURVE TO THE LEFT THROUGH A CENTRAL ANGLE OF $51^{\circ}58'43''$, HAVING A RADIUS OF 1000.00 FEET AND A CHORD BEARING SOUTH $19^{\circ}40'01''$ EAST, 876.41 FEET;

EXHIBIT 1 (cont.)

5) THENCE SOUTH 45°39'22" EAST, 164.52 FEET TO A POINT ON THE WESTERLY BOUNDARY CORNER OF MEADOWS FILING NO. 11, PARCEL 3, A PLAT RECORDED IN THE DOUGLAS COUNTY RECORDS;

THENCE ALONG THE BOUNDARY OF SAID PLAT THE FOLLOWING TWENTY-FIVE (25) COURSES:

1) THENCE SOUTH 45°39'41" EAST, 33.74 FEET;

2) THENCE SOUTH 44°35'42" EAST, 365.06 FEET;

3) THENCE SOUTH 45°39'22" EAST, 182.22 FEET;

4) THENCE SOUTH 35°54'26" EAST, 609.12 FEET;

5) THENCE SOUTH 46°25'04" EAST, 211.24 FEET;

6) THENCE NORTH 51°37'11" EAST, 846.47 FEET;

7) THENCE NORTH 44°48'35" EAST, 206.31 FEET;

8) THENCE NORTH 31°04'00" EAST, 206.31 FEET;

9) THENCE NORTH 22°19'50" EAST, 86.23 FEET;

10) THENCE NORTH 19°14'29" EAST, 439.85 FEET;

11) THENCE NORTH 01°28'10" EAST, 89.39 FEET;

12) THENCE NORTH 41°25'25" WEST, 143.98 FEET

13) THENCE NORTH 22°01'53" WEST, 98.70 FEET;

14) THENCE NORTH 35°39'51" WEST, 158.43 FEET;

15) THENCE NORTH 73°04'40" WEST, 29.07 FEET TO A POINT ON A NON-TANGENT CURVE;

16) THENCE 97.86 FEET ALONG THE ARC OF A CURVE TO THE LEFT THROUGH A CENTRAL ANGLE OF 101°56'36", HAVING A RADIUS OF 55.00 FEET AND A CHORD BEARING NORTH 34°02'58" WEST, 85.45 FEET TO A POINT OF REVERSE CURVE;

17) THENCE 20.16 FEET ALONG THE ARC OF A CURVE TO THE RIGHT THROUGH A CENTRAL ANGLE OF 64°09'28", HAVING A RADIUS OF 18.00 FEET AND A CHORD BEARING NORTH 52°56'32" WEST, 19.12 FEET TO A POINT OF TANGENT;

18) THENCE NORTH 20°51'48" WEST, 151.00 FEET TO A POINT OF CURVE;

UNOFFICIAL COPY

EXHIBIT 1 (cont.)

19) THENCE 91.22 FEET ALONG THE ARC OF A CURVE TO THE RIGHT THROUGH A CENTRAL ANGLE OF $05^{\circ}23'17''$, HAVING A RADIUS OF 970.00 FEET AND A CHORD BEARING NORTH $18^{\circ}10'10''$ WEST, 91.18 FEET TO A POINT OF TANGENT;

20) THENCE NORTH $15^{\circ}28'31''$ WEST, 253.69 FEET TO A POINT OF CURVE;

21) THENCE 19.59 FEET ALONG THE ARC OF A CURVE TO THE RIGHT THROUGH A CENTRAL ANGLE OF $05^{\circ}33'20''$, HAVING A RADIUS OF 202.00 FEET AND A CHORD BEARING NORTH $12^{\circ}41'51''$ WEST, 19.58 FEET TO A POINT OF TANGENT;

22) THENCE NORTH $09^{\circ}55'11''$ WEST, 62.55 FEET TO A POINT OF CURVE;

23) THENCE 20.56 FEET ALONG THE ARC OF A CURVE TO THE LEFT THROUGH A CENTRAL ANGLE OF $05^{\circ}33'20''$, HAVING A RADIUS OF 212.00 FEET AND A CHORD BEARING NORTH $12^{\circ}41'51''$ WEST, 20.55 FEET TO A POINT OF TANGENT;

24) THENCE NORTH $15^{\circ}28'31''$ WEST, 34.58 FEET TO A POINT OF CURVE;

25) THENCE 43.98 FEET ALONG THE ARC OF A CURVE TO THE RIGHT THROUGH A CENTRAL ANGLE OF $90^{\circ}00'00''$, HAVING A RADIUS OF 28.00 FEET AND A CHORD BEARING NORTH $29^{\circ}31'29''$ EAST, 39.60 FEET TO THE TRUE POINT OF BEGINNING. CONTAINING 463.681 ACRES.

EXCEPT THAT PORTION OF MEADOWS BOULEVARD, CONTAINING 2.750 ACRES.

THE NET AREA FOR THE ABOVE DESCRIBED PARCEL CONTAINS 460.931 ACRES, MORE OR LESS.

BEARINGS ARE BASED ON THE NORTH LINE OF THE NE 1/4 OF SECTION 33, TOWNSHIP 7 SOUTH, RANGE 67 WEST OF THE SIXTH PRINCIPAL MERIDIAN BEARING NORTH $89^{\circ}26'52''$ WEST.

EXHIBIT 1 (cont.)

MEADOWS P.D. - PARCEL 4

02-03-03

A PARCEL OF LAND LOCATED IN SECTIONS 32, 33 AND 34, TOWNSHIP 7 SOUTH, RANGE 67 WEST OF THE SIXTH PRINCIPAL MERIDIAN, AND THE SW 1/4 OF SECTION 3, SECTIONS 4 AND 5, THE NORTH HALF OF SECTION 9, AND THE NW 1/4 OF SECTION 10, TOWNSHIP 8 SOUTH, RANGE 67 WEST, TOWN OF CASTLE ROCK, COUNTY OF DOUGLAS, STATE OF COLORADO, MORE PARTICULARLY DESCRIBED AS FOLLOWS:

BEGINNING AT THE NORTH 1/4 CORNER OF SAID SECTION 4, SAID POINT ALSO BEING THE SOUTH 1/4 CORNER OF SAID SECTION 33; THENCE ALONG THE EAST LINE OF THE NW 1/4 OF SAID SECTION 4, SOUTH $01^{\circ}10'44''$ EAST, 2657.82 FEET TO THE CENTER 1/4 CORNER OF SAID SECTION 4; THENCE ALONG THE NORTH LINE OF THE SE 1/4 OF SAID SECTION 4, SOUTH $89^{\circ}56'40''$ EAST, 2630.79 FEET TO THE EAST 1/4 CORNER OF SAID SECTION 4; THENCE ALONG THE NORTH LINE OF THE NW 1/4 OF SAID SECTION 3, NORTH $89^{\circ}21'12''$ EAST, 1298.22 FEET; THENCE SOUTH $00^{\circ}13'25''$ EAST, 656.22 FEET; THENCE SOUTH $53^{\circ}00'04''$ WEST, 2129.31 FEET TO A POINT ON NON-TANGENT CURVE; THENCE 477.92 FEET ALONG THE ARC OF A CURVE TO THE RIGHT THROUGH A CENTRAL ANGLE OF $43^{\circ}07'21''$, HAVING A RADIUS OF 635.00 FEET AND A CHORD BEARING SOUTH $39^{\circ}37'07''$ EAST, 466.72 FEET TO A POINT ON A NON-TANGENT CURVE; THENCE 637.88 FEET ALONG THE ARC OF A CURVE TO THE RIGHT THROUGH A CENTRAL ANGLE OF $24^{\circ}21'55''$, HAVING A RADIUS OF 1500.00 FEET AND A CHORD BEARING SOUTH $61^{\circ}37'40''$ EAST, 633.09 FEET TO A POINT OF TANGENT; THENCE SOUTH $49^{\circ}34'42''$ EAST, 100.00 FEET TO A POINT ON THE NORTHWESTERLY RIGHT-OF-WAY OF WOLFENSBERGER ROAD; THENCE ALONG SAID RIGHT-OF-WAY THE FOLLOWING TEN (10) COURSES:

- 1) SOUTH $45^{\circ}33'18''$ WEST, 444.55 FEET;
- 2) THENCE SOUTH $48^{\circ}52'17''$ WEST, 70.68 FEET;
- 3) THENCE SOUTH $37^{\circ}26'05''$ WEST, 257.80 FEET;
- 4) THENCE SOUTH $37^{\circ}21'08''$ WEST, 207.43 FEET;
- 5) THENCE SOUTH $32^{\circ}29'43''$ WEST, 58.04 FEET;
- 6) THENCE SOUTH $32^{\circ}27'51''$ WEST, 21.82 FEET;
- 7) THENCE SOUTH $32^{\circ}31'29''$ WEST, 101.75 FEET;
- 8) THENCE SOUTH $30^{\circ}53'53''$ WEST, 249.68 FEET;
- 9) THENCE SOUTH $38^{\circ}19'36''$ WEST, 236.07 FEET;
- 10) THENCE SOUTH $38^{\circ}53'07''$ WEST, 22.62 FEET TO A POINT ON THE SOUTH LINE OF THE NORTH HALF OF THE NE 1/4 OF SAID SECTION 9;

THENCE ALONG SAID SOUTH LINE, NORTH $89^{\circ}47'36''$ WEST, 2057.37 FEET TO THE SOUTHEAST CORNER OF THE NORTH HALF OF THE NW 1/4 OF SAID SECTION 9; THENCE ALONG THE SOUTH LINE OF THE NORTH HALF OF THE NW 1/4 OF SAID SECTION 9, NORTH $89^{\circ}19'30''$ WEST, 2713.62 FEET TO THE SOUTHWEST CORNER OF THE NORTH HALF OF THE NW 1/4 OF SAID SECTION 9; THENCE ALONG THE WEST LINE OF THE NORTH HALF OF THE NW 1/4 OF SAID SECTION 9, NORTH $01^{\circ}15'11''$ WEST, 1304.93 FEET TO

EXHIBIT 1 (cont.)

THE SOUTHEAST CORNER OF SAID SECTION 5; THENCE ALONG THE SOUTH LINE OF THE SE 1/4 OF SAID SECTION 5, SOUTH 89°33'32" WEST, 2641.14 FEET TO THE SOUTH 1/4 CORNER OF SAID SECTION 5; THENCE ALONG THE WEST LINE OF THE SE 1/4 OF SAID SECTION 5, NORTH 00°24'01" WEST, 2611.25 FEET TO THE CENTER 1/4 CORNER OF SAID SECTION 5; THENCE ALONG THE SOUTH LINE OF THE NW 1/4 OF SAID SECTION 5, SOUTH 89°39'04" WEST, 1262.34 FEET TO THE SOUTHEAST CORNER OF A PARCEL OF LAND DESCRIBED IN BOOK 760 AT PAGE 148; THENCE ALONG THE EASTERLY BOUNDARY OF SAID PARCEL, NORTH 00°53'42" WEST, 2358.98 FEET; THENCE NORTH 89°36'42" EAST, 455.75 FEET TO A POINT OF CURVE; THENCE 820.34 FEET ALONG THE ARC OF A CURVE TO THE RIGHT THROUGH A CENTRAL ANGLE OF 48°42'25", HAVING A RADIUS OF 965.00 FEET AND A CHORD BEARING SOUTH 66°02'06" EAST, 795.86 FEET; THENCE SOUTH 41°40'53" EAST, 586.10 FEET TO A POINT OF CURVE; THENCE 858.87 FEET ALONG THE ARC OF A CURVE TO THE LEFT THROUGH A CENTRAL ANGLE OF 84°07'08", HAVING A RADIUS OF 585.00 FEET AND A CHORD BEARING SOUTH 83°44'27" EAST, 783.78 FEET; THENCE NORTH 54°11'39" EAST, 740.78 FEET TO A POINT OF CURVE; THENCE 295.65 FEET ALONG THE ARC OF A CURVE TO THE RIGHT THROUGH A CENTRAL ANGLE OF 14°32'32", HAVING A RADIUS OF 1165.00 FEET AND A CHORD BEARING NORTH 61°28'15" EAST, 294.89 FEET; THENCE NORTH 68°44'31" EAST, 123.42 FEET TO A POINT ON THE WESTERLY RIGHT-OF-WAY OF FOOTHILLS DRIVE AS RECORDED AT RECEPTION NUMBER 8727782; THENCE ALONG SAID RIGHT-OF-WAY, NORTH 68°44'19" EAST, 100.12 FEET TO THE SOUTHWEST CORNER OF WEST MEADOWS DRIVE AS RECORDED AT RECEPTION NUMBER 8727779 OF THE DOUGLAS COUNTY RECORDS; THENCE ALONG THE SOUTHERLY RIGHT-OF-WAY OF WEST MEADOWS DRIVE THE FOLLOWING SIX (6) COURSES:

- 1) NORTH 68°44'07" EAST, 84.03 FEET TO A POINT OF CURVE;
- 2) THENCE 241.34 FEET ALONG THE ARC OF A CURVE TO THE RIGHT THROUGH A CENTRAL ANGLE OF 26°51'02", HAVING A RADIUS OF 515.00 FEET AND A CHORD BEARING NORTH 82°09'38" EAST, 239.14 FEET TO A POINT OF TANGENT;
- 3) THENCE SOUTH 84°24'51" EAST, 335.25 FEET TO A POINT OF CURVE;
- 4) THENCE 622.67 FEET ALONG THE ARC OF A CURVE TO THE LEFT THROUGH A CENTRAL ANGLE OF 60°59'08", HAVING A RADIUS OF 585.00 FEET AND A CHORD BEARING NORTH 65°05'35" EAST, 593.69 FEET TO A POINT OF TANGENT;
- 5) THENCE NORTH 34°36'01" EAST, 112.26 FEET TO A POINT OF CURVE;
- 6) THENCE 30.23 FEET ALONG THE ARC OF A CURVE TO THE RIGHT THROUGH A CENTRAL ANGLE OF 86°35'26", HAVING A RADIUS OF 20.00 FEET AND A CHORD BEARING NORTH 77°53'45" EAST, 27.43 FEET TO A POINT ON THE SOUTHERLY RIGHT-OF-WAY OF SAID MEADOWS BOULEVARD;

EXHIBIT 1 (cont.)

THENCE ALONG SAID RIGHT-OF-WAY OF MEADOWS BOULEVARD THE FOLLOWING NINE (9) COURSES:

1) THENCE 535.05 FEET ALONG THE ARC OF A CURVE TO THE LEFT THROUGH A CENTRAL ANGLE OF $33^{\circ}52'26''$, HAVING A RADIUS OF 905.00 FEET AND A CHORD BEARING SOUTH $75^{\circ}44'45''$ EAST, 527.29 FEET TO A NON-TANGENT LINE;

2) THENCE SOUTH $89^{\circ}01'30''$ EAST, 101.00 FEET TO A NON-TANGENT CURVE;

3) THENCE 126.45 FEET ALONG THE ARC OF A CURVE TO THE LEFT THROUGH A CENTRAL ANGLE OF $07^{\circ}54'02''$, HAVING A RADIUS OF 917.00 FEET AND A CHORD BEARING NORTH $77^{\circ}03'23''$ EAST, 126.35 FEET TO A POINT OF REVERSE CURVE;

4) THENCE 30.80 FEET ALONG THE ARC OF A CURVE TO THE RIGHT THROUGH A CENTRAL ANGLE OF $88^{\circ}14'30''$, HAVING A RADIUS OF 20.00 FEET AND A CHORD BEARING SOUTH $63^{\circ}44'35''$ EAST, 27.85 FEET;

5) THENCE NORTH $69^{\circ}40'46''$ EAST, 71.00 FEET;

6) NORTH $20^{\circ}19'14''$ WEST, 12.24 FEET TO A POINT OF CURVE;

7) THENCE 30.22 FEET ALONG THE ARC OF A CURVE TO THE RIGHT THROUGH A CENTRAL ANGLE OF $86^{\circ}34'14''$, HAVING A RADIUS OF 20.00 FEET AND A CHORD BEARING NORTH $22^{\circ}57'53''$ EAST, 27.43 FEET TO A POINT OF REVERSE CURVE;

8) THENCE 614.41 FEET ALONG THE ARC OF A CURVE TO THE LEFT THROUGH A CENTRAL ANGLE OF $38^{\circ}53'54''$, HAVING A RADIUS OF 905.00 FEET AND A CHORD BEARING NORTH $46^{\circ}48'03''$ EAST, 602.68 FEET TO A POINT OF TANGENT;

9) THENCE NORTH $27^{\circ}21'06''$ EAST, 235.94 FEET TO WESTERLY LINE OF THE MEADOWS FILING NO. 11 - PARCEL 14;

THENCE ALONG THE BOUNDARY OF SAID PARCEL 14 THE FOLLOWING FIVE (5) COURSES:

1) SOUTH $61^{\circ}32'27''$ EAST, 181.87 FEET;

2) THENCE SOUTH $44^{\circ}11'05''$ EAST, 345.76 FEET, WHENCE THE POINT OF BEGINNING FOR THIS LEGAL DESCRIPTION BEARS SOUTH $44^{\circ}11'05''$ EAST, 145.10 FEET;

3) THENCE NORTH $18^{\circ}48'34''$ EAST, 536.43 FEET;

4) THENCE NORTH $43^{\circ}01'10''$ WEST, 76.68 FEET;

5) THENCE NORTH $38^{\circ}41'24''$ WEST, 373.21 FEET TO A POINT ON THE SOUTHEASTERLY

EXHIBIT 1 (cont.)

RIGHT-OF-WAY OF SAID MEADOWS BOULEVARD;

THENCE CONTINUING ALONG SAID RIGHT-OF-WAY THE FOLLOWING FIVE (5) COURSES:

1) 536.48 FEET ALONG THE ARC OF A CURVE TO THE RIGHT THROUGH A CENTRAL ANGLE OF 29°24'52", HAVING A RADIUS OF 1045.00 FEET AND A CHORD BEARING NORTH 52°21'31" EAST, 530.61 FEET TO A POINT OF TANGENT;

2) THENCE NORTH 67°03'57" EAST, 1045.49 FEET TO A POINT OF CURVE;

3) THENCE 1079.23 FEET ALONG THE ARC OF A CURVE TO THE LEFT THROUGH A CENTRAL ANGLE OF 34°15'28", HAVING A RADIUS OF 1805.00 FEET AND A CHORD BEARING NORTH 49°56'13" EAST, 1063.23 FEET TO A POINT OF TANGENT;

4) THENCE NORTH 32°48'29" EAST, 1091.56 FEET TO A POINT OF CURVE;

5) THENCE 323.88 FEET ALONG THE ARC OF A CURVE TO THE RIGHT THROUGH A CENTRAL ANGLE OF 06°18'05", HAVING A RADIUS OF 2945.00 FEET AND A CHORD BEARING NORTH 35°57'31" EAST, 323.72 FEET TO THE MOST WESTERLY CORNER OF THE MEADOWS FILING NO. 3, RECORDED AT RECEPTION NUMBER 8802433 OF THE DOUGLAS COUNTY RECORDS;

THENCE ALONG THE SOUTHWESTERLY AND SOUTHEASTERLY BOUNDARY OF SAID PLAT THE FOLLOWING TWO (2) COURSES:

1) THENCE SOUTH 50°31'20" EAST, 325.45 FEET;

2) THENCE NORTH 50°40'10" EAST, 467.00 FEET, MORE OR LESS, TO A POINT ON THE SOUTHWESTERLY RIGHT-OF-WAY OF SANTA FE DRIVE;

THENCE ALONG SAID RIGHT-OF-WAY THE FOLLOWING TWO (2) COURSES:

1) SOUTH 39°19'44" EAST, 15.38 FEET TO A POINT OF CURVE;

2) THENCE 115.88 FEET ALONG THE ARC OF A CURVE TO THE LEFT THROUGH A CENTRAL ANGLE OF 06°54'58", HAVING A RADIUS OF 960.00 FEET AND A CHORD BEARING SOUTH 42°47'13" EAST, 115.81 FEET TO THE MOST NORTHERLY CORNER OF A PARCEL OF LAND RECORDED IN BOOK 1441, PAGE 419 OF THE DOUGLAS COUNTY RECORDS; THENCE ALONG THE BOUNDARY OF SAID PARCEL THE FOLLOWING THREE (3) COURSES:

1) SOUTH 34°54'43" WEST, 302.78 FEET;

2) THENCE SOUTH 55°05'17" EAST, 295.16 FEET;

EXHIBIT 1 (cont.)

3) THENCE NORTH $34^{\circ}54'43''$ EAST, 302.78 FEET TO A POINT ON THE SOUTHWESTERLY RIGHT-OF-WAY OF SAID SANTA FE DRIVE;

THENCE ALONG SAID RIGHT-OF-WAY THE FOLLOWING SIX (6) COURSES:

1) THENCE 245.85 FEET ALONG THE ARC OF A CURVE TO THE LEFT THROUGH A CENTRAL ANGLE OF $14^{\circ}40'23''$, HAVING A RADIUS OF 960.00 FEET AND A CHORD BEARING SOUTH $71^{\circ}16'04''$ EAST, 245.18 FEET TO A POINT OF TANGENT;

2) THENCE SOUTH $78^{\circ}36'15''$ EAST, 1262.01 FEET TO A POINT OF CURVE;

3) THENCE 771.09 FEET ALONG THE ARC OF A CURVE TO THE RIGHT THROUGH A CENTRAL ANGLE OF $47^{\circ}00'00''$, HAVING A RADIUS OF 940.00 FEET AND A CHORD BEARING SOUTH $55^{\circ}06'15''$ EAST, 749.65 FEET TO A POINT OF TANGENT;

4) THENCE SOUTH $31^{\circ}36'15''$ EAST, 893.31 FEET TO A POINT OF CURVE;

5) THENCE 498.72 FEET ALONG THE ARC OF A CURVE TO THE RIGHT THROUGH A CENTRAL ANGLE OF $19^{\circ}50'37''$, HAVING A RADIUS OF 1440.00 FEET AND A CHORD BEARING SOUTH $21^{\circ}40'57''$ EAST, 496.24 FEET TO A POINT OF TANGENT;

6) THENCE SOUTH $11^{\circ}45'38''$ EAST, 548.77 FEET TO A POINT ON THE EAST LINE OF THE WEST HALF OF THE SE 1/4 OF SAID SECTION 34;

THENCE ALONG THE EAST LINE OF THE WEST HALF OF SAID SE 1/4, SOUTH $00^{\circ}50'08''$ EAST, 767.91 FEET TO A POINT ON THE NORTH LINE OF SAID SECTION 3;

THENCE ALONG THE NORTH LINE OF SAID SECTION 3, SOUTH $88^{\circ}58'39''$ WEST, 3939.59 FEET TO THE NORTHEAST CORNER OF SAID SECTION 4; THENCE ALONG THE NORTH LINE OF THE NE 1/4 OF SAID SECTION 4, SOUTH $89^{\circ}29'14''$ WEST, 2627.14 FEET TO THE POINT OF BEGINNING, CONTAINING 1380.686 ACRES, MORE LESS.

EXCEPT THAT PORTION OF COACHLINE ROAD AND FOOTHILLS DRIVE CONTAINING 18.079 ACRES. MORE LESS.

THE NET AREA FOR THE ABOVE DESCRIBED PARCEL CONTAINS 1,362.607 ACRES, MORE OR LESS.

BEARINGS ARE BASED ON THE EAST LINE OF THE NW 1/4 OF SECTION 4, TOWNSHIP 8 SOUTH, RANGE 67 WEST OF THE SIXTH PRINCIPAL MERIDIAN BEARING SOUTH $01^{\circ}10'44''$ EAST.

EXHIBIT 1 (cont.)

MEADOWS P.D. - PARCEL 5

02/03/03

A PARCEL OF LAND BEING A PART OF SECTIONS 9 AND 10 OF TOWNSHIP 8 SOUTH, RANGE 67 WEST OF THE SIXTH PRINCIPAL MERIDIAN, TOWN OF CASTLE ROCK, COUNTY OF DOUGLAS, STATE OF COLORADO, AND BEING DESCRIBED AS FOLLOWS:

"BEGINNING" AT THE SOUTHEAST CORNER OF THE SOUTHEAST QUARTER OF SAID SECTION 9 AND CONSIDERING THE SOUTH LINE OF SAID SOUTHEAST QUARTER TO BEAR NORTH 89°53'17" WEST, WITH ALL BEARINGS CONTAINED HEREIN RELATIVE THERETO; THENCE NORTH 89°53'17" WEST, ALONG SAID SOUTH LINE OF THE SOUTHEAST QUARTER, A DISTANCE OF 1296.99 FEET TO THE SOUTHWEST CORNER OF THE EAST HALF OF THE SOUTHEAST QUARTER OF SAID SECTION 9; THENCE NORTH 00°21'50" WEST, ALONG THE WEST LINE OF THE EAST HALF OF THE SOUTHEAST QUARTER OF SAID SECTION 9, A DISTANCE OF 2614.77 FEET TO THE SOUTHWEST CORNER OF THE EAST HALF OF THE NORTHEAST QUARTER OF SAID SECTION 9; THENCE NORTH 00°45'59" WEST, ALONG THE WEST LINE OF SAID EAST HALF OF THE NORTHEAST QUARTER, A DISTANCE OF 12.62 FEET TO THE SOUTHERLY RIGHT-OF-WAY LINE OF WOLFENSBERGER ROAD; THENCE NORTHEASTERLY ALONG SAID SOUTHERLY RIGHT-OF-WAY LINE THE FOLLOWING 5 (FIVE) COURSES:

- 1) NORTH 20°01'43" EAST, A DISTANCE OF 26.84 FEET;
- 2) NORTH 26°26'59" EAST, A DISTANCE OF 498.38 FEET;
- 3) NORTH 30°39'54" EAST, A DISTANCE OF 399.68 FEET;
- 4) NORTH 41°25'59" EAST, A DISTANCE OF 580.76 FEET;
- 5) NORTH 37°17'18" EAST, A DISTANCE OF 26.73 FEET TO A POINT ON THE SOUTHWESTERLY BOUNDARY OF THAT TRACT OF LAND DESCRIBED IN BOOK 286 AT PAGE 680 IN THE RECORDS OF THE DOUGLAS COUNTY CLERK AND RECORDER;

THENCE DEPARTING SAID SOUTHERLY RIGHT-OF-WAY LINE, SOUTH 40°01'36" EAST, ALONG SAID WESTERLY LINE, A DISTANCE OF 701.92 FEET; THENCE CONTINUING ALONG SAID LINE, NORTH 89°43'57" EAST, A DISTANCE OF 2607.39 FEET TO THE EASTERLY LINE OF THE NORTHWEST QUARTER OF SAID SECTION 10; THENCE SOUTH 00°35'11" EAST, ALONG THE EASTERLY LINE OF THE NORTHWEST QUARTER AND THE EASTERLY LINE OF THE SOUTHWEST QUARTER OF SAID SECTION 10, A DISTANCE OF 2095.22 FEET TO THE SOUTHEAST CORNER OF THE NORTHEAST QUARTER OF THE SOUTHWEST QUARTER OF SAID SECTION 10; THENCE NORTH 89°28'03" WEST, ALONG THE SOUTH LINE OF SAID NORTHEAST QUARTER OF THE SOUTHWEST QUARTER, A DISTANCE OF 1304.45 FEET TO THE NORTHEAST CORNER OF THE SOUTHWEST QUARTER OF THE SOUTHWEST QUARTER OF SAID SECTION 10; THENCE SOUTH 00°25'13" EAST, ALONG THE EAST LINE OF SAID SOUTHWEST QUARTER OF THE SOUTHWEST QUARTER, A DISTANCE OF 1305.36 FEET TO THE SOUTHEAST CORNER OF SAID SOUTHWEST QUARTER OF THE SOUTHWEST QUARTER; THENCE NORTH 89°28'47" WEST, ALONG THE SOUTH LINE OF SAID SOUTHWEST QUARTER OF THE SOUTHWEST QUARTER, A DISTANCE OF 1307.23 FEET TO THE "POINT OF BEGINNING".

EXHIBIT 1 (cont.)

CONTAINING 266.060 ACRES OR 11,589,605 SQUARE FEET, MORE OR LESS.

UNOFFICIAL COPY

UNOFFICIAL COPY

THE MEADOWS PD ZONING REGULATIONS

FOURTH AMENDMENT

TOWN OF CASTLE ROCK, COLORADO

Approved April 14, 2003

APR - 9 2003

TABLE OF CONTENTS

Section I.	Purpose	2
Section II.	General Provisions	4
Section III.	Definitions	5
Section IV.	Use Areas and Overall Project Standards	7
Section V.	Permitted Uses	11
Section VI.	Development Standards	18
Section VII.	Signs	19
Section VIII.	Parking	19
Section IX.	Town Center Streets	20
Section X.	Landscaping	20
Section XI.	Development Plans/Plats	20
Section XII.	Transitional Use	21
Exhibit A	The Meadows Signage Criteria	
Exhibit B	Town Center Streets	
Exhibit C	Town Center Landscaping	

**SECTION I
PURPOSE**

1.1 **Introduction.** The initial Preliminary PD Site Plan for The Meadows was approved and recorded on December 14, 1984. The last major amendment to the Preliminary PD Site Plan and The Meadows PD Zoning Ordinance (“The Meadows PD”) was approved as part of Ordinance Number 86-42 and was recorded on January 30, 1987 (“Third Amendment”). The Third Amendment established the current total unit count within The Meadows at 13,758 dwelling units. An additional 369 dwelling units were allocated to the South Meadows, which was approved by a separate ordinance (Ordinance 85-28 recorded October 9, 1985). The dwelling unit count was explicitly apportioned within individual neighborhoods in The Meadows as follows:

	2,594	
Neighborhood A	2,594	
Neighborhood B	4,761	
Neighborhood C	2,444	
Neighborhood D	2,153	
Neighborhood E	1,806	
 Subtotal	 13,758	
 South Meadows	 369	
 Total	 14,127	

The Meadows Preliminary PD Site Plan Fourth Amendment (hereinafter the “The Fourth Amended Preliminary PD Site Plan”) and The Meadows PD Zoning Regulations Fourth Amendment (hereinafter the “Amended Zoning Regulations”) do not cover the following areas in The Meadows:

Neighborhood A	Filing Nos. 1,2,5,7,8, 9, and 11	1,459 units
Neighborhood B	Filing No. 11	553 units
Neighborhood C	Filing Nos. 6, 9, 11, and 12	1,172 units
	Total	3,184 units

Neighborhood A is completely platted and a Final PD Site Plan has been filed and recorded for all of the areas within that neighborhood.

The intent of The Fourth Amended Preliminary PD Site Plan and these Amended Zoning Regulations is to establish the maximum number of units allowable as a principal use within the community at 10,869 dwelling units. This includes the above referenced dwelling units and, and the additional 7,685 dwelling units as set forth further in these Amended Zoning Regulations.

The Meadows PD also required that 1,105.8 acres of Public Land and Open Space, along with an additional 347.4 acres from the South Meadows, be dedicated to the Town of Castle Rock as Public Land and Open Space. This would result in a total dedication requirement of 1,453.2 acres of Public Land and Open Space. A total of 240.8 acres of Public Land and Open space has been either dedicated to or committed for dedication to the Town of Castle Rock. The Fourth Amended Preliminary PD Site Plan and these Amended Zoning Regulations include 1,212.4 acres of Public Land and Open Space resulting in a projected total of 1,453.2 acres available for Public Land and Open Space dedication.

1.2 Fourth Amendment. These Amended Zoning Regulations and The Fourth Amended Preliminary PD Site Plan have been designed for the following purposes:

- a. to amend, replace, simplify, clarify and update the zoning on certain portions of The Meadows PD (Ordinance No. 84-48, as amended);
- b. to promote economic vitality by consolidating commercial, retail, office and institutional uses with residential uses in a mixed-use Town Center Neighborhood Use Area and to establish appropriate regulations for such area;
- c. to incorporate the South Meadows PD (Ordinance No. 85-28) and the undeveloped portions of The Meadows PD into one consolidated PD with updated development regulations;
- d. to minimize sprawl, traffic congestion, and adverse environmental impacts;
- e. to preserve natural land features such as ridges, drainages and steep slopes as open space within the neighborhoods;
- f. to provide an environment that will attract a variety of new industries and other employment opportunities;
- g. to allow the development of The Meadows to be responsive to the changing needs of the community over time;
- h. to provide substantial park and open space areas throughout The Meadows to meet the recreational needs of the community; and
- i. to provide a Development Agreement between the Town of Castle Rock and The Meadows for the purpose of water rights dedication and vesting.

UNOFFICIAL COPY

**SECTION II
GENERAL PROVISIONS**

- 2.1 Adoption/Authorization.** These Amended Zoning Regulations and the Fourth Amended Preliminary PD Site Plan have been adopted by the Town Council by Ordinance No. _____, on the 14th day of April, 2003, and have been incorporated therein, pursuant to Section 17.60 of Title 17 (Zoning) of the Castle Rock Municipal Code after appropriate public notice and hearing.
- 2.2 Applicability.** The Fourth Amended Preliminary PD Site Plan and these Amended Zoning Regulations shall run with and bind all landowners of record, their successors, heirs, or assigns within that portion of The Meadows that is more particularly described on the Fourth Amended Preliminary PD Site Plan (the "Property"). These regulations shall supercede all previous zoning regulations pertaining to the Property, as previously amended, including but not limited to Ordinance 84-48, Ordinance 85-28, and Ordinance 86-42 (the "Prior Ordinances"). Subsequent to the effective date of this Ordinance, the Prior Ordinances shall have no further force or effect with respect to the development and use of the Property.
- 2.3 Maximum Level of Development.** The total number of dwelling units or total commercial, industrial or other non-residential floor area approved for development within the established Use Areas is the maximum allowed for platting and development. Subject to the terms of the Development Agreement, the actual number of dwellings or floor area approved will be determined at the time of Final Plat and Final PD Site Plan stage of review based upon environmental constraints, utility and street capacity, compatibility with surrounding land uses, and other relevant factors.
- 2.4 Relationship of Town of Castle Rock Regulations.** The provisions of the Fourth Amended Preliminary PD Site Plan and these Amended Zoning Regulations shall prevail and govern the development of the Property, provided, however, that, subject to the terms of the Development Agreement, where the provisions of the Fourth Amended Preliminary PD Site Plan and these Amended Zoning Regulations do not address a particular subject, the relevant provisions of the Town of Castle Rock Zoning Ordinance, as amended, or other applicable provisions of the Municipal Code shall be applicable.
- 2.5 Severability of Provisions.** In the event that any provision hereof shall be determined to be illegal or void by the final order of any court of competent jurisdiction, the remaining provisions shall remain in full force and effect.
- 2.6 Development Agreement.** In addition to these regulations, certain provisions of the development of the Property are controlled by an agreement between the Town of Castle Rock and the owners of the Property. Among other things, this agreement provides for a vesting of the property rights set forth in the Fourth Amended Preliminary PD Site Plan, and establishes a water bank for The Meadows. This agreement, entitled The Meadows Fourth Amendment Development Agreement between Castle Rock Development Company, Castle Rock Land Co., LLC and Town of Castle Rock, was adopted by the Town on the 14th day of April, 2003, by Ordinance No. _____. In the event of a conflict between the terms of

these Amended Zoning Regulations and the Development Agreement, the Development Agreement shall control.

SECTION III DEFINITIONS

The following definitions shall apply to terms used in these Amended Zoning Regulations. Any terms used herein which are not defined, but are defined in the relevant provisions of the Castle Rock Municipal Code or in the generally applicable ordinances of the Town of Castle Rock having to do with land use, zoning and subdivision shall have the meaning set forth therein, unless the use of such terms in the context of these Amended Zoning Regulations requires otherwise.

3.1 Accessory Dwelling Unit. A dwelling unit permitted on the same lot as a single-family dwelling unit. An Accessory Dwelling Unit shall not exceed the greater of 800 sq. ft. or 33% of the floor area of the primary dwelling unit and must be located in the same structure as the primary dwelling unit or in an accessory structure that contains other uses accessory to the primary dwelling unit. Accessory Dwelling Units shall not be included in the calculation of total dwelling units for a neighborhood use area or for the Fourth Amended Preliminary PD Site Plan, unless the water tap size needed for the primary dwelling unit and the accessory dwelling unit exceeds the tap size for one Single Family Equivalent. In such case, the Accessory Dwelling Unit shall be included in the calculation for the dwelling units in such neighborhood use area.

3.2 Apartment Units. Attached dwelling units that are not individually owned but are rented or leased to the occupants thereof.

3.3 Attached Dwelling Units. Dwelling units that are physically connected to other dwelling units. As used herein, the term attached dwelling units includes, but is not limited to, apartment units, condominium units, patio homes, and townhome units.

3.4 Building Ground Coverage.

(a) That portion of the ground on any building site which is covered by structures having a floor, walls and fully enclosed roof.

(b) Building Ground Coverage does not include open decks or patio decks, tennis courts, surface, front and side porches, underground or partially underground parking areas if such partially underground parking areas do not protrude more than six feet (6') from the average surrounding grade, roadways, bike paths or pedestrian ways, or such other uses not meeting the definition of paragraph (a) above.

3.5 Building Height. The vertical distance from the average finished grade surrounding a structure to the uppermost point of the roof structure. Chimneys, ventilators, elevator housings, skylights, solar collectors, air conditioning and heating units, antennas and necessary mechanical appurtenances usually constructed above roof level are not to be considered in determining building height.

- 3.6 **Building Setback.** The horizontal distance between a platted lot line and a building or structure.
- 3.7 **Detached Dwelling Units.** Dwelling units that are not physically connected to other dwelling units. Detached Dwelling Units include, but are not limited to, single-family units and patio homes.
- 3.8 **Gross Acreage.** Acreage that includes the area up to the center-line of adjacent roads, alleys, and other right-of-ways.
- 3.9 **Maximum Non-Residential Floor Area.** As used herein, and in particular for purposes of interpreting Table IVA, "Maximum Non-Residential Floor Area" shall mean the maximum gross floor area of enclosed structures that is devoted to uses other than residential uses, or other than uses accessory to residential uses. In any neighborhood use area, this value shall represent the amount of floor area that may be constructed in addition to floor area devoted to residential uses, to uses accessory to residential uses, or to areas serving residential uses. In calculating the non-residential floor area of a mixed-use building, the floor area of all residential dwelling units, as well as hallways, service areas, lobbies or other areas serving the residential portion of the building, shall be excluded from the calculation of Maximum Non-Residential Floor Area.
- 3.10 **Private Open Space.** Usable open space that remains in private ownership and is privately controlled, constructed and maintained. The accessibility and availability of such Private Open Space to occupants of dwelling units for whose use it is intended is to be perpetually protected by appropriate covenants, and some mechanism is to be established to control, construct and maintain the property.
- 3.11 **Public Land Dedication.** That property designated to be deeded to the Town of Castle Rock for public use, as more particularly set forth in section 5.5 of these Amended Zoning Regulations, to satisfy the land dedication requirements of the Subdivision Ordinances of the Town of Castle Rock.
- 3.12 **Single-Family Dwelling Unit.** A building designed primarily for the occupancy of one family. Single-Family Dwelling Units may be attached (may share common walls) or be detached, but may only contain more than one dwelling unit if the second unit meets the definition of Accessory Dwelling Unit under Section 3.1 of these Amended Zoning Regulations. Single-Family Dwelling Unit owners shall own the land beneath such units and the land surrounding such units. Common undivided ownership of elements or facilities that are located in areas other than the lot surrounding such units is permitted.
- 3.13 **Usable Open Space.** Space, suitable for landscaping, passive and/or active recreation, gardens, view protection and enhancement, and/or other appropriate uses, which may remain in private ownership.

**SECTION IV
USE AREAS AND OVERALL PROJECT STANDARDS**

- 4.1 **Use Areas.** The Property shall be divided into general use areas as the same are located on the Fourth Amended Preliminary PD Site Plan, approved contemporaneously herewith and incorporated by reference into these Amended Zoning Regulations. The Fourth Amended Preliminary PD Site Plan designates seven use areas as well as open space areas.

The aggregate number of acres, the maximum number of dwelling units, and the Maximum Non-Residential Floor Area, and the allowable Use Area Categories for each Neighborhood Use Area shall be as follows:

UNOFFICIAL COPY
[The Remainder of This Page Intentionally Left Blank]

TABLE IVA
USE AREA CATEGORIES AND DENSITY CAPS

NEIGHBOR/ HOOD USE AREAS	USE AREA CATEGORIES	GROSS ACREAGE	PERCENT OF TOTAL ACREAGE	MAX. NUMBER OF DWELLING UNITS	MAX. NON- RESIDENTIAL FLOOR AREA/F.A.R.
B	R-SF R-LMF	31.7	1.2	253	N.A.
C	R-SF	94.7	3.5	493	N.A.
D	R-SF	388.5	14.4	1,467	N.A.
E	R-SF	281.1	10.5	1,470	N.A.
SM TC	R-LMF TC	26.9 269.3	1.0 10.0	323 3,679	N.A. 2.0
C-O-I	C O I	388.3	14.4	N.A.	0.60
PUBLIC LAND DEDICATION	PLD	190.6	7.1	N.A.	N.A.
OPEN SPACE	OSD	1022.0	37.9	N.A.	N.A.
Total	N.A.	2,693.1	100.0	7,685	N.A.

4.2 Use Area Boundaries and Modifications. To allow for response to changing conditions over the extended planning and development period inherent in the project, modifications, including those described in subsections (a), (b) and (c) below, may be made to the Fourth Amended Preliminary PD Site Plan as part of the approval of a Final PD Site Plan subject to the express limitations of this Section 4.2.

- (a) Neighborhoods. Minor boundary modifications to the Neighborhood Use Areas may be permitted in order to provide for adjustments in gross acreage and the total number of residential units that may be lost as a result of land needed for Public Land Dedications within a Neighborhood Use Area, such as the proposed recreation site in the South Meadows area. Adjustments to the boundaries must be directly correlated to the impact of the dedication of Public Lands and the net change in the total number of allowed units resulting from the loss of land. If residential units lost as a result of Public Land Dedication can not be recouped by minor boundary modification such lost units may be transferred to another Neighborhood Use Area, however, in no case, may (i) the number of residential units be increased in a particular Neighborhood Use Area unless the number of residential units in another Neighborhood Use Area is decreased by the same

amount due to the impact of Public Land Dedication; (ii) the acreage of any one Neighborhood Use Area change by more than 20%; or (iii) the total amount of Public Land and Open Space acreage set forth in Table IVA above be reduced.

(b) Schools. The location of school sites within a Neighborhood Use Area may be modified as appropriate to accommodate changes in adjacent land, provided that any such modification shall accommodate the projected school population, based on the Douglas County Board of Education student ratios and be acceptable to the Douglas County School District.

(c) Public Land and Open Space.

(1) Parks and Recreation. The location of park and recreation areas, including but not limited to trails, may be modified at the time of Final PD Site Plan if the modified locations are to provide better access and better relationships between the residential areas and park and recreation facilities.

(2) Open Space. The owner of any Property subject to these Amended Zoning Regulations or the Town of Castle Rock may, at the time of Final PD Site Plan review, seek to develop steep slopes, drainages and flood plains considered undevelopable under the present plan. Development of such areas may be approved if mapping and engineering studies show that development is feasible. A Major Amendment to the Preliminary PD Site Plan is required to change the zoning of Open Space to accommodate any residential development, but in no case shall the total acreage of open space be reduced.

(3) Public Facilities. The location of any public or quasi-public facilities including but not limited to schools, well sites, water production facilities, utilities, and intermodal transportation centers, may be modified at the time of Final PD Site Plan so long as the total acreage of open space is not reduced.

(4) Intent. It is the intent of these Zoning Regulations to provide for 1,212.6 acres of Public Land Dedication and Open Space. Minor boundary adjustments are permitted pursuant to Section 4.2(a), however in no case shall the total acreage of Public Land Dedication and Open Space be less than 1,212.6 acres.

4.3 Private Open Space. Residential areas in Neighborhood Use Areas B, C, D, E and SM shall contain a minimum amount of Private Open Space equal to 10% of the total acreage contained in such areas. Any such Private Open Space shall be perpetually protected by appropriate protective covenants and the title of such Private Open Space shall be held by non-profit corporate entities or associations, which shall bear the responsibility of maintaining and controlling such Private Open Space. No Private Open Space shall be required in the TC Neighborhood Use Area or the C-O-I Neighborhood Use Areas.

4.4 **Schools.** Subject to Section 4.2(b), school sites for public or private schools shall be reserved as indicated on the Fourth Amended Preliminary PD Site Plan for four (4) elementary schools (10 acres each).

4.5 **Road Alignments.** The Fourth Amended Preliminary PD Site Plan is intended to depict general locations of roadways. Recognizing that final road alignments are subject to engineering studies, minor realignments of roadways are expected. Alignment modifications that generally relocate a roadway shown on the Fourth Amended Preliminary PD Site Plan can be accomplished with consent of the Town of Castle Rock and owner of the Property through the platting or Final PD Site Plan process without any amendment to these Amended Zoning Regulations or to the Fourth Amended Preliminary PD Site Plan.

4.6 **Underground Utility Requirements.** All utility distribution lines shall be placed underground. No overhead line in existence as of the date these Amended Zoning Regulations are adopted need be relocated.

4.7 **Temporary Uses.** Temporary uses are permitted as follows:

- (a) Single-Family and Attached Dwelling Units may be utilized as model homes and/or sales and information offices if the unit so utilized is a permitted use in the Neighborhood Use Area where it is located. Any such use shall be discontinued when all comparable dwelling units within the Property have been sold or leased.
- (b) Mobile sales and information units may be utilized in any Neighborhood Use Area provided no such mobile sales and information unit is erected until a site plan for such unit has first been submitted to the Town of Castle Rock for review and approval. No such unit may be maintained in any area described in a Final PD Site Plan more than ninety (90) days after a certificate of occupancy has been issued for the final residential or commercial structure within the area being served by such unit without the express approval of the Director of Development Services or such other Town of Castle Rock official authorized in the same or similar capacity.
- (c) Construction offices and material storage shall be permitted in all Neighborhood Use Areas during and for a period of ninety (90) days after cessation of actual construction in those areas being served by such construction office or material storage area.

4.8 **Building Setback and Lot Area.** To provide flexibility for innovative design and good planning principles, the development of criteria for minimum lot area and minimum Building Setbacks and separations within and adjacent to development tracts within all Neighborhood Use Areas other than the TC neighborhood will be reserved, unless otherwise provided, until the presentation of Final PD Site Plans, but no Final PD Site Plan for such Neighborhood Use Areas shall be presented for consideration or approved which does not establish these criteria. The minimum Building Setbacks, minimum lot area and separation criteria set forth on a Final PD Site Plan, or any subsequent variations from such criteria,

shall be subject to approval by the Director of Development Services or such other Town of Castle Rock official authorized in the same or similar capacity. To encourage full block closure and enhance the pedestrian experience, no Building Setback between buildings shall be required within the TC Neighborhood Use Area. Eaves, overhangs, fireplaces, patios, decks, stoops, front and side porches, fire escapes, mechanical units, or similar architectural appurtenances may project up to four feet (4') into a required setback, but no such projection shall extend beyond any lot line of the lot on which it is located except in the TC Neighborhood Use Area. Except in the TC Neighborhood Use Area, in no case shall any encroachment be permitted within either a Town of Castle Rock dedicated easement or right-of-way.

SECTION V PERMITTED USES

UNOFFICIAL COPY

Permitted Uses, Accessory Uses and Uses by Special Review for each Neighborhood Use Area shall be as follows. In the TC and C-Q-I Neighborhood Use Areas, any allowed use may exist on the same lot or in the same building as any other allowed use for such Neighborhood Use Area. In the event that these Amended Zoning Regulations do not address a specific, proposed use, these Amended Zoning Regulations and the Permitted Use most closely fitting the proposed use shall regulate:

5.1 NEIGHBORHOOD USE AREAS C, D, and E: SINGLE-FAMILY (R-SF).

A. Permitted Uses

1. Single-Family Dwelling Units.
2. Community information center and informational kiosks.
3. Public or private roadways.
4. Public or private recreational and park uses and facilities including, but not limited to, tennis courts; swimming pools; and jogging, hiking, riding and bike trails.
5. Public or non-public schools.
6. Public or private utilities, including, conduit for future utility or distribution lines, and appurtenant facilities.
7. Signage, as provided by Section VII.
8. Community sales offices.

9. Public and quasi-public facilities.

B. Accessory Uses (permitted only in conjunction with a Permitted Use)

1. Home occupation so long as the total use area does not exceed 33% of the floor area of the primary dwelling unit.
2. Off-street parking.
3. Open spaces and lakes, to include storm water drainage detention areas.
4. Small in-home day care centers subject to the licensing requirements of the State of Colorado.

UNOFFICIAL COPY

5. Accessory Dwelling Units.

C. Uses Permitted by Special Review

1. Caretakers' residence.
2. Churches and other religious institutions.
3. Large in-home day care centers and day care centers subject to the licensing requirements of the State of Colorado.
4. Elderly assisted care living facilities subject to the licensing requirements of the State of Colorado and not located within 1,500 feet of another elderly assisted care living facility.
5. Any use which is deemed to be compatible with the permitted uses specified in Section 5.1 and which furthers the overall purposes of the Fourth Amended Preliminary PD Site Plan and these Amended Zoning Regulations.

5.2 NEIGHBORHOOD USE AREAS B AND SM: SINGLE-FAMILY, MULTI-FAMILY (R-SF, R-LMF)

A. Permitted Uses

1. All uses permitted under Section 5.1 of these Amended Zoning Regulations.
2. Attached Dwelling units.

B. Accessory Uses (permitted only in conjunction with a Permitted Use)

1. Those accessory uses permitted under Section 5.1 of these Amended Zoning Regulations.

C. Uses Permitted by Special Review

1. Those Uses Permitted by Special Review under Section 5.1 of these Amended Zoning Regulations.

5.3 NEIGHBORHOOD USE AREA TC: TOWN CENTER (TC)

Upon completion of all development within TC Neighborhood Use Area, there shall be a minimum of 15,000 square feet of developed retail and service commercial uses and a minimum of 15,000 square feet of developed office uses within the TC Neighborhood Use

Area.

UNOFFICIAL COPY

A. Permitted Uses

1. All permitted uses under Sections 5.1 and all permitted uses under Section 5.2 of these Amended Zoning Regulations.
2. Automobile parking lots, parking structures or garages.
3. Automobile repair garage and/or convenience service station provided that wrecked, junked or abandoned motor vehicles shall not be stored on the property; (Ord. No. 91-24, 7/91).
4. Bakery; up to twenty percent (20%) wholesale.
5. Banks/financial institutions.
6. Catering services.
7. Clinics.
8. Clubs, lodges and service organizations.
9. Confectionery shop.
10. Fine arts gallery and/or fine arts studio.
11. Government and public facilities, including but not limited to libraries, courthouses, police and fire stations, emergency care facilities, and offices.

12. Hospitals, nursing homes, assisted living facilities, senior housing and other health care or senior living facilities including clinics and medical offices.
13. Hotel/motel.
14. Indoor/outdoor recreation facilities.
15. Laboratories except those that involve any hazardous process or emit noxious noise, dust and odor.
16. Laundry, coin-operated, and dry cleaners collection stations.
17. Museum/civic institution.
18. Offices. Upon completion of all development within the TC Neighborhood Use Area, there shall be a minimum of 15,000 square feet of developed office within the TC Neighborhood Use Area.
19. Personal service shops, such as barber, beauty parlor.
20. Pharmacy.
21. Post office.
22. Printing/copy shops.
23. Public or private streets conforming to the street sections established by Section IX of these Amended Zoning Regulations.
24. Repair, rental, service of any item retailed in the TC Neighborhood Use Area.
25. Restaurants, cafes and other places serving food and beverages.
26. Retail business stores.
27. Retail and Service Commercial. Upon completion of all development within TC Neighborhood Use Area, there shall be a minimum of 15,000 square feet of developed retail and service commercial uses within the TC Neighborhood Use Area.
28. Studios, including television and radio broadcasting stations, but excluding antenna towers and microwave dishes.
29. Tailoring.
30. Theaters.

31. Upholstering.
32. Utilities office.
33. Day care centers.
34. Churches, synagogues, places of worship.
35. Small animal clinics.
36. Non-profit and community organization offices.
37. Community Sales Offices.

UNOFFICIAL COPY

38. Transit Facilities.
39. Auditoriums.
40. Outdoor entertainment facilities, including amphitheatres.
41. Private clubs.
42. College or university schools; proprietary schools.
43. Amusement arcades and centers.

B. Accessory Uses (permitted only in conjunction with a Permitted Use)

1. Accessory Dwelling Units.
2. Accessory uses as provided by Section 17.66.200 of the Castle Rock Municipal Code except that Accessory Dwelling Units shall be allowed.
3. All permitted uses under Sections 5.1 and all permitted uses under Section 5.2 of these Amended Zoning Regulations.

C. Uses Permitted by Special Review

1. Ambulance service.
2. Caretaker in residence.
3. Mortuary.

4. Personal Wireless Service Facilities (including, telecommunications, cellular, radio and television antenna towers), subject to Chapter 17.92 of the Castle Rock Municipal Code.
5. Any use which is deemed to be compatible with the permitted uses specified in Section 5.3 and which furthers the overall purposes of the Fourth Amended Preliminary PD Site Plan and these Amended Zoning Regulations.

5.4 NEIGHBORHOOD USE AREA C-O-I: COMMERCIAL, OFFICE, INDUSTRIAL, (C, O, I,). Industrial uses shall not be permitted in the following two parcels: i) the approximately 32 acre, C-O-I parcel located just east of the intersection of Meadows Boulevard and Cherokee Drive; and ii) the approximately 8.7 acre, C-O-I parcel known as The Meadows Filing No. 11, Parcels 8 and

UNOFFICIAL COPY

A. Permitted Uses

1. Any light industrial uses except those specifically prohibited by the Castle Rock Municipal Code Chapter 17.52
2. Commercial uses.
3. Hospital, nursing homes, assisted living facilities, senior housing and other health care or senior living facilities.
4. Office/warehouses.
5. Offices.
6. Parking lots, structures and garages.
7. Research facilities and laboratories.
8. Restaurants.
9. Retail (repair services, showrooms and support services).
10. Transit terminals/park-and-ride facilities.
11. Veterinarian clinics and kennels.
12. Churches, synagogues, places of worship.
13. Public or non-public schools, colleges and universities.

14. Personal Wireless Service Facilities (including, telecommunications, cellular, radio and television antenna), subject to Chapter 17.92 of the Castle Rock Municipal Code.
15. Car washes.
16. All uses permitted under Sections 5.1, 5.2 and 5.3 of these Amended Zoning Regulations, except Single-Family Dwelling Units, Caretakers' residence, small and large in-home day care, Accessory Dwelling Units, and Attached Dwelling Units.

B. Accessory Uses (permitted only in conjunction with a Permitted Use)

1. As provided by Section 17.080.030 of the Castle Rock Municipal Code.

C. Uses by Special Review

1. Wind generators.
2. Any use which is deemed to be compatible with the permitted uses specified in Section 5.4 and which furthers the overall purposes of the Fourth Amended Preliminary PD Site Plan and these Amended Zoning Regulations.

5.5 NEIGHBORHOOD USE AREA PUBLIC LAND DEDICATION.

A. Permitted Uses

1. Open Space
2. Parks, playgrounds and picnic areas, excluding camping and overnight parking.
3. Community centers.
4. Community recreational centers.
5. Public buildings, including but not limited to schools, libraries, fire and police stations.

5.6 NEIGHBORHOOD USE AREA OPEN SPACE.

A. Permitted Uses

1. Natural open space.
2. Paved and unpaved trails.
3. Parking.

4. Interpretive Learning Centers.
5. Public and private reservoirs, lakes and ponds.
6. Community gardens.
7. Wildlife Habitat and corridors.

5.7 ACCESSORY USES PERMITTED IN ALL NEIGHBORHOOD USE AREAS.

A. Permitted Uses

1. Underground utility and communication distribution lines, specifically including, but not limited to, cable televisions and fiber optic.

2. Roadways, bikepaths, and pedestrian and equestrian trails.

3. Parking areas.

4. Open Space, as defined in Section 5.6 above.

5. Storm water detention areas and facilities.

6. Fences.

7. Water wells and water distribution facilities, including but limited to pumping stations, aquifer recharge and reinjection facilities and water treatment and storage facilities.

8. Sanitary sewer piping and pumping stations.

9. Public buildings, including but not limited to schools, libraries, fire and police stations.

10. Community centers.

11. Community recreational centers.

B. Uses Permitted by Special Review.

1. Electric substations and gas regulation stations.

2. Above ground utility transmission lines.

**SECTION VI
DEVELOPMENT STANDARDS**

All development shall conform to the maximum number of units, Maximum Non-Residential Floor Area, Building Height and Building Ground Coverage requirements provided in the Table VIA as follows:

**TABLE VIA
NEIGHBORHOOD USE AREA ZONING RESTRICTIONS**

	*ZONE B	ZONE C	ZONE D	ZONE E	ZONE SM	ZONE TC	ZONE C-O-1
MAXIMUM F.A.R. (NON-RESIDENTIAL USES)	N.A.	N.A.	N.A.	N.A.	N.A.	1.5	0.60
MINIMUM SETBACKS BETWEEN RESIDENTIAL AND NON-RESIDENTIAL USES	30	30	30	30	30	0	0
MAXIMUM BUILDING HEIGHT	35'	35'	35'	35'	50'	60' (**75')	60' (**75')
MAXIMUM BUILDING COVERAGE	N.A.	N.A.	N.A.	N.A.	N.A.	100%	60%

*For the purpose of this Table VIA, "Zone" shall mean Neighborhood Use Area.

**Increase in Maximum Building Height to 75' permitted as a Use By Special Review only.

SECTION VII SIGNAGE

Signage in all Neighborhood Use Areas of The Meadows shall be permitted pursuant to the Castle Rock Municipal Code Title 19, except as may be permitted pursuant to The Meadows Signage Criteria attached hereto as **Exhibit A**.

SECTION VIII PARKING

8.1 Parking. Off-street parking is required for all Neighborhood Use Areas. Except as provided in Section 8.2 below, the number and size of all required parking spaces are to be in conformance with the applicable Town of Castle Rock regulations at the time of Final PD Site Plan review. The developer may request fewer or smaller spaces at the time of Final PD Site Plan review. Such request shall be administratively granted if it can be demonstrated to the satisfaction of Town staff that shared parking is warranted because the peak parking demand for two or more uses occurs at different times or it is otherwise demonstrated that

provision of a lesser number of spaces or spaces of lesser size will still provide adequate off-street parking for the proposed use(s).

- 8.2 **Town Center.** Off-street parking for the TC Neighborhood Use Area shall be provided in accordance with the parking ratios provided at Table VIIIA. On-street parking within 300' of a proposed use may be counted to meet the parking requirements for retail and other non-residential uses. Assignment of on-street parking shall be allocated at the time of approval of the Final PD Site Plan.

**TABLE VIIIA
PARKING REQUIREMENTS**

USE	PARKING SPACE REQUIREMENTS
Multi-Family Dwellings Units	One space per bedroom
Retail	One space for each 250 s.f. of useable retail floor area
Restaurant	One space per each 100 s.f. of dining space floor area
Hotel/Motel	One space for each guest room
Office	One space per 330 s.f. of useable office space
Civic/Institutional Uses	One space for each 330 s.f. of floor area

**SECTION IX
TOWN CENTER STREETS**

In the TC Neighborhood Use Area, streets shall be constructed pursuant to the right-of-way widths, streetscapes and visibility triangles provided in the street sections and intersections diagrams attached hereto as **Exhibit B**. Street alignments are subject to modification and adjustment as provided by Section 4.2 of these Amended Zoning Regulations.

**SECTION X
LANDSCAPING**

In the TC Neighborhood Use Area, street tree planting and tree lawn areas shall be provided. All landscaping shall conform to the Castle Rock water conservation standards. Tree planting areas and tree lawn areas may be located within public right-of-way and shall meet the requirements shown at Table XA and the diagrams attached hereto as **Exhibit C**.

TABLE XA

STREET	MAXIMUM TREE SPACING	TREE LAWN
Boulevard	35 feet on center	5'
Market Street	35 feet on center	N/A
Local Collector	35 feet on center	5'
Residential Streets	35 feet on center	5'
Alleys	N/A	N/A
Street Types – B, C, D, E	35 feet on center	5'

UNOFFICIAL COPY

**SECTION XI
DEVELOPMENT PLANS/PLATS**

Submission of Final PD Site Plans and Plats and Additional Information. Following approval of the Fourth Amended Preliminary PD Site Plan, the landowners may submit a Preliminary Plat for any portion or all of the Neighborhood Use Areas as are then ready for development. No building permit shall be issued until a Final PD Site Plan and Final Subdivision Plat have been approved for such portion of the Property by the Town and duly recorded. Building permits for temporary uses may be issued at the discretion of the Director of Development Services or such other Town of Castle Rock official authorized in the same or similar capacity.

**SECTION XII
TRANSITIONAL USE**

After approval of the Fourth Amended Preliminary PD Site Plan, any portion of the Property described above, which has not been subject to a Preliminary Plat may be used for agricultural purposes. Agricultural uses, for purposes of this section, shall mean farming, ranching, gardening, and buildings accessory to these uses. In no event shall commercial feed yards, poultry, or hog farms be permitted. Any activity permitted by this section shall be considered to be a valid pre-existing non-conforming use within the area described above until a Preliminary Plat for such area or areas has been approved.

**Exhibit A
to The Meadows Amended Zoning Regulations**

THE MEADOWS SIGNAGE CRITERIA

The purpose of this Signage Criteria is to establish a graphic standard that provides for destination direction and identification to ensure that residents, tenants and visitors can quickly and easily make their way through The Meadows community. Signage installed within The Meadows boundaries shall be designed appropriately to contribute to the overall identity and wayfinding system of the community.

Signage in all Neighborhood Use Areas of The Meadows shall require a separate permit and shall be permitted pursuant to the Town of Castle Rock Municipal Code Title 19, except as may be allowed by this Meadows Signage Criteria and these Amended Zoning Regulations. Signage prohibited in the Town of Castle Rock Sign Code 19.04.042 Prohibited Signs shall not be permitted in The Meadows Signage Criteria.

The following Sign Types shall be permitted in all Neighborhood Use Areas unless restricted in specific Neighborhood Use Areas by this Signage Criteria.

Signs in Business Area: Freestanding Signs

A “freestanding sign” in a business area is any sign which is used to identify shopping centers, industrial sites, retail districts and commercial sites.

- a. A freestanding sign may be erected in the COI Neighborhood Use Areas and shall not exceed a maximum sign area of fifty (50) square feet per sign face (one hundred (100) square feet total) or eight (8) feet in height from grade to top of sign. The formula for calculating maximum total area as a ratio of building/lot frontage shall be the lesser of Town Sign Code or two and one-half (2½) square feet of sign for each linear foot of building frontage for the first two hundred (200) feet of building frontage (or one and one-half (1½) square feet of sign for each linear foot of lot frontage) and one-half (½) square foot for each additional linear foot. In no event shall the maximum sign area exceed fifty (50) square feet per side.
- b. The maximum total copy area allowed for a freestanding sign shall be eighty percent (80%) of the sign area, allowing for proportional margins on all sides.
- c. A freestanding sign may be illuminated externally, internally, and by individual halo illuminated letters. Internally illuminated signs may not have translucent faces. Fluorescent lighting shall not be allowed.

**Signs in Town Center Area: Freestanding Signs
("Freestanding General Business Sign")**

A freestanding "general business" sign is any sign which is issued to identify a business, profession, service, product or activity conducted, sold or offered on the premises where such a sign is located.

- a. A freestanding general business sign may be erected in Town Center
- b. A freestanding general business sign shall not exceed a maximum sign area of fifty (50) square feet per sign face (one hundred (100) square feet total) or eight (8) feet in height from grade to top of sign.
- c. The maximum total copy area allowed for a freestanding general business sign shall be eighty percent (80%) of the sign area, allowing for proportional margins on all sides.
- d. A freestanding general business sign may be illuminated externally, internally, and by individual halo illuminated letters. Internally illuminated signs may not have translucent faces. Fluorescent lighting shall not be allowed.
- e. A freestanding general business sign may be installed on a setback ratio to the property line of one foot (1') of setback to one foot (1') of sign height, as long as it does not project over the plane of the property line.
- f. Freestanding general business signs shall be restricted for use for each single-pad site of 15,000 square feet or greater and 100 linear feet or greater of frontage on a primary access road.

**General Sign Types Referred to Throughout Town of Castle
Rock Sign Code Ordinance**

Wall Signs

A "wall sign" is any sign erected flat against an exterior wall, supported by the wall, and having the sign face parallel to and not more than twelve (12) inches from the wall surface.

- a. Wall signs may be mounted on a building or parking deck.
- b. Wall signs may be horizontal (landscape orientation, read from left to right) or vertical (vertical orientation, read from top to bottom) in direction.
- c. Wall signs may be illuminated externally, internally, and by individual halo illuminated letters. Internally illuminated signs may not have translucent faces. Fluorescent lighting shall not be allowed.
- d. Wall signs shall not exceed twenty-five percent (25%) of the wall area.
- e. The size of a horizontal wall sign shall not exceed six (6) feet high, as measured perpendicular from the horizontal. The width of a vertical wall sign shall not exceed six (6) feet wide, as measured perpendicular from the vertical.

Temporary Signs

1. Special Event Signs

- a. Signs announcing an event occurring up to two times per year on retail sites only. These signs must receive a banner sign permit and are counted towards the maximum number of banner permitted per year.
- b. One single-sided sign per event as required for event is allowed.
- c. A special event sign shall not exceed thirty-two (32) square feet in area or twelve (12) feet in height from grade to top of sign.
- d. The display period shall not to exceed ten (10) days and promotional banners are allowed but must comply with Town of Castle Rock Sign Code Regulation 19.04.047.

2. Project Announcement Signs

- a. Sign announcing a new project under construction.
- b. One (1) sign per street front per site.
- c. A project announcement sign shall measure 6' x 8' and can be single or double faced.
- d. Height above grade shall not exceed twelve (12) feet.
- e. Copy may contain name of the project and logo, rendering of project, developer, architect, lender, and contractor.
- f. Project announcement signs may be installed at commencement of construction and must be removed no later than date of certificate of occupancy.

3. Construction Directional Signs

- a. Construction directional signs are for the purpose of identifying construction entrance and traffic routing.
- b. Signs shall measure a maximum of 2' x 3' and may be single or double faced.
- c. Height above grade to top of sign shall not exceed four (4) feet unless mounted on construction fence or barricade. In the case of a fence mounted construction directional sign, no portion of the sign shall extend above the fence edge.
- d. Construction directional signs may be installed at commencement of construction and must be removed no later than date of certificate of occupancy.

4. Commercial Leasing/ For Sale Sign

- a. Leasing/for sale signs are for the purpose of providing leasing or sales information for use only when vacancy/availability exists.
- b. Number of allowable signs shall be one (1) sign per street front per site. Individual retail pads may be considered to be an individual site.
- c. Signs shall measure a maximum of 3' x 6', may be single or double-faced and shall not exceed eighteen (18) square feet.
- d. Height above grade to top of sign shall not exceed six (6) feet.

Flags

Flags may be erected according to the Castle Rock Municipal Code Title 19, except that corporate logo flags are permitted per the following stipulations.

- a. If flown with governmental flags.
- b. Corporate logo flags may be flown only for the purpose of identifying residential and commercial sales offices and business locations.
- c. In no instance shall the corporate logo flag square footage area exceed that of the government flag with which it is flown.
- d. Corporate flags shall be counted against total maximum square footage allowed.

Awning signs

An "awning sign" is any awning containing signage used to identify a business, profession, service product or activity conducted, sold or offered on the premises where such sign is located. Awning signs are considered wall signs for the purpose of determining maximum wall sign coverage.

- a. Awning Signs shall be permitted only in the Town Center and COI Neighborhood Use Areas.
- b. The copy/artwork on an awning sign shall not exceed the area and size that is allowed for a wall sign on the wall to which it is attached. The copy area of the awning sign must be less than twenty-five percent (25%) of the awning.

Projecting Signs

A "projecting sign" is any sign, other than an awning, which projects perpendicular to a building and which is attached to a building or other permanent structure. Projecting signs are permitted only in the Town Center zoned area.

- a. The horizontal portion of any projecting sign shall not be more than six (6) feet and six (6) inches in length, measured from the building face.
- b. The projecting sign area shall not exceed six (6) square feet.
- c. Projecting signs, other than awning or canopy signs, shall be allowed over pedestrian sidewalks, walkways and corridors, with the following restrictions:

<u>Vertical Clearance</u>	<u>Maximum Projection</u>
7 feet or less	3 inches
7 or 8 feet	12 inches
8 feet or more	4 feet

Sign Types Not Specifically Addressed in Sign Code

Directional Signs

A “Directional Sign” is any sign, which directs the public to various locations, for instance, but not limited to, the retail, apartments, hotel or parking areas.

- a. Directional signage affixed to a building or other structure shall not exceed a maximum sign area of six (6) square feet.
- b. Directional signage setbacks shall be a minimum of five (5) feet.
- c. Directional signs may be located on collector and arterial roadways.
- d. A free standing Directional Sign shall not exceed a maximum area of fifteen (15) square feet. The width of a free standing directional sign shall not exceed three (3) feet wide, as measured perpendicular from the vertical.

Entrance Gateways

An “Entrance Gateway” is an entry feature, which may be freestanding, span across an area or attach to a building or structure. This feature identifies the entrance of a particular area. Such features are subject to review and approval by the Town at the time of Final PD Site Plan.

- a. Pedestrian Entrance Gateways which span across a public right-of-way to designate entrances to parks, trails, plazas, neighborhoods or other such areas, may be erected subject to Town of Castle Rock building codes pertaining to clearances, encroachments, etc.
- b. Vehicular Entrance Gateways, which span across the public right-of-way, are permitted only in the Town Center zoned area and are subject to approval of a Right-of-Way Encroachment Permit.

Directory Map

A “directory map” is a map listing the occupants within a shopping center, industrial sites, retail districts, residential sales offices, office districts, commercial sites, district and other community facilities.

- a. A directory map may be freestanding, mounted to a wall, or mounted to a vertical support.
- b. A directory map is used to provide wayfinding information.
- c. A directory map may be located on collector and arterial roadways, if posted within a designated pullout area outside of traffic flow.
- d. A directory map may be installed immediately adjacent to the property line (no setback) as long as it does not project over the plane of the property line.
- e. A directory map, mounted to a vertical support, shall not exceed twenty-four (24) square feet.
- f. No Directory Map Signage may encroach into the public right-of-way.

Additional Provisions

Streetscape Banners

The primary purpose of the Banner Program is to enhance the streetscape and feature community activities, institutions, milestones or historical events that reinforce the character and identity of The Meadows.

Banners will promote institutions and events contributing to the public good and benefit the cultural life of The Meadows and Castle Rock. Banners may be permitted only in the Town Center, and COI Neighborhood Use Areas. Banners may not be used for advertising a specific product or corporate entity. Banners may be proposed and sponsored by for-profit and non-profit entities, corporations and individuals provided they meet the following criteria for content and objectives.

In the event a designated Committee of the Home and Business Owners Association desires to own and maintain banner installation hardware, then the Committee will oversee banner content, programming, dismantle and maintenance on behalf of The Meadows.

- a. Banners are to be made from approved fabric only, and must be resistant to fading and tearing. Recommended fabrics include acrylic fiber canvas or rip-stop nylon.
- b. Banners shall be a maximum of 32" wide by a maximum of 80" long
- c. Banners are to be mounted on existing street light poles via horizontal supports at the top and bottom. The bottom of the banner is to be not less than 8'-0" above grade and must not encroach over roadway.
- d. Banners may display graphics and/or messages based on the criteria described in this document and on general aesthetic and suitability standards.
- e. Banners may be mounted to a vertical support, attached to a building or parking deck and, only in the case of Market Street of the Town Center, span the street.
- f. Banners, which are mounted to a vertical support, may be integrated onto street and pedestrian light poles, with the approval of the owner of the vertical support.

A-Frame Signs

An "A-Frame" Sign is a double-faced, movable, self-supporting sign that is normally placed in public view during business hours. A-Frame Signs are permitted only in the Town Center zoned areas.

- a. A-Frame Signs may be located in pedestrian areas without obstructing the public right-of-way provided that the sidewalk is at least ten (10) feet wide and the sign is located so as to not pose a danger to, impede or hinder pedestrian traffic.
- b. A-Frame Signs shall have a character of permanence by utilizing long lasting construction and materials.
- c. A-Frame Signs shall measure 2½' wide by 3½' high (30"x42") and cannot exceed a maximum sign area of 8.75 square feet per sign face or forty-two (42) inches in height.

Plaza Directional Signs

Installations of plaza directional signs for use in identifying the closest entrance to a neighborhood/village or facility shall comply with The Town of Castle Rock Sign Plaza Program in accordance with the approved permit specifications.

UNOFFICIAL COPY

**Exhibit A
to The Meadows Amended Zoning Regulations**

THE MEADOWS SIGNAGE CRITERIA

The purpose of this Signage Criteria is to establish a graphic standard that provides for destination direction and identification to ensure that residents, tenants and visitors can quickly and easily make their way through The Meadows community. Signage installed within The Meadows boundaries shall be designed appropriately to contribute to the overall identity and wayfinding system of the community.

Signage in all Neighborhood Use Areas of The Meadows shall require a separate permit and shall be permitted pursuant to the Town of Castle Rock Municipal Code Title 19, except as may be allowed by this Meadows Signage Criteria and these Amended Zoning Regulations. Signage prohibited in the Town of Castle Rock Sign Code 19.04.042 ~~Prohibited Signs shall not be permitted in The Meadows Signage Criteria.~~

~~The following Sign Types shall be permitted in all Neighborhood Use Areas unless restricted in specific Neighborhood Use Areas by this Signage Criteria.~~

Signs in Business Area: Freestanding Signs

A “freestanding sign” in a business area is any sign which is used to identify shopping centers, industrial sites, retail districts and commercial sites.

- a. A freestanding sign may be erected in the COI Neighborhood Use Areas and shall not exceed a maximum sign area of fifty (50) square feet per sign face (one hundred (100) square feet total) or eight (8) feet in height from grade to top of sign. The formula for calculating maximum total area as a ratio of building/lot frontage shall be the lesser of Town Sign Code or two and one-half (2½) square feet of sign for each linear foot of building frontage for the first two hundred (200) feet of building frontage (or one and one-half (1½) square feet of sign for each linear foot of lot frontage) and one-half (½) square foot for each additional linear foot. In no event shall the maximum sign area exceed fifty (50) square feet per side.
- b. The maximum total copy area allowed for a freestanding sign shall be eighty percent (80%) of the sign area, allowing for proportional margins on all sides.
- c. A freestanding sign may be illuminated externally, internally, and by individual halo illuminated letters. Internally illuminated signs may not have translucent faces. Fluorescent lighting shall not be allowed.

**Signs in Town Center Area: Freestanding Signs
("Freestanding General Business Sign")**

A freestanding "general business" sign is any sign which is issued to identify a business, profession, service, product or activity conducted, sold or offered on the premises where such a sign is located.

- a. A freestanding general business sign may be erected in Town Center
- b. A freestanding general business sign shall not exceed a maximum sign area of fifty (50) square feet per sign face (one hundred (100) square feet total) or eight (8) feet in height from grade to top of sign.
- c. The maximum total copy area allowed for a freestanding general business sign shall be eighty percent (80%) of the sign area, allowing for proportional margins on all sides.
- d. A freestanding general business sign may be illuminated externally, internally, and by individual halo illuminated letters. Internally illuminated signs may not have translucent faces. Fluorescent lighting shall not be allowed.
- e. A freestanding general business sign may be installed on a setback ratio to the property line of one foot (1') of setback to one foot (1') of sign height, as long as it does not project over the plane of the property line.
- f. Freestanding general business signs shall be restricted for use for each single-pad site of 15,000 square feet or greater and 100 linear feet or greater of frontage on a primary access road.

**General Sign Types Referred to Throughout Town of Castle
Rock Sign Code Ordinance**

Wall Signs

A "wall sign" is any sign erected flat against an exterior wall, supported by the wall, and having the sign face parallel to and not more than twelve (12) inches from the wall surface.

- a. Wall signs may be mounted on a building or parking deck.
- b. Wall signs may be horizontal (landscape orientation, read from left to right) or vertical (vertical orientation, read from top to bottom) in direction.
- c. Wall signs may be illuminated externally, internally, and by individual halo illuminated letters. Internally illuminated signs may not have translucent faces. Fluorescent lighting shall not be allowed.
- d. Wall signs shall not exceed twenty-five percent (25%) of the wall area.
- e. The size of a horizontal wall sign shall not exceed six (6) feet high, as measured perpendicular from the horizontal. The width of a vertical wall sign shall not exceed six (6) feet wide, as measured perpendicular from the vertical.

Temporary Signs

1. Special Event Signs

- a. Signs announcing an event occurring up to two times per year on retail sites only. These signs must receive a banner sign permit and are counted towards the maximum number of banner permitted per year.
- b. One single-sided sign per event as required for event is allowed.
- c. A special event sign shall not exceed thirty-two (32) square feet in area or twelve (12) feet in height from grade to top of sign.
- d. The display period shall not to exceed ten (10) days and promotional banners are allowed but must comply with Town of Castle Rock Sign Code Regulation 19.04.047.

2. Project Announcement Signs

- a. Sign announcing a new project under construction.
- b. One (1) sign per street front per site.
- c. A project announcement sign shall measure 6' x 8' and can be single or double faced.
- d. Height above grade shall not exceed twelve (12) feet.
- e. Copy may contain name of the project and logo, rendering of project, developer, architect, lender, and contractor.
- f. Project announcement signs may be installed at commencement of construction and must be removed no later than date of certificate of occupancy.

3. Construction Directional Signs

- a. Construction directional signs are for the purpose of identifying construction entrance and traffic routing.
- b. Signs shall measure a maximum of 2' x 3' and may be single or double faced.
- c. Height above grade to top of sign shall not exceed four (4) feet unless mounted on construction fence or barricade. In the case of a fence mounted construction directional sign, no portion of the sign shall extend above the fence edge.
- d. Construction directional signs may be installed at commencement of construction and must be removed no later than date of certificate of occupancy.

4. Commercial Leasing/ For Sale Sign

- a. Leasing/for sale signs are for the purpose of providing leasing or sales information for use only when vacancy/availability exists.
- b. Number of allowable signs shall be one (1) sign per street front per site. Individual retail pads may be considered to be an individual site.
- c. Signs shall measure a maximum of 3' x 6', may be single or double-faced and shall not exceed eighteen (18) square feet.
- d. Height above grade to top of sign shall not exceed six (6) feet.

Flags

Flags may be erected according to the Castle Rock Municipal Code Title 19, except that corporate logo flags are permitted per the following stipulations.

- a. If flown with governmental flags.
- b. Corporate logo flags may be flown only for the purpose of identifying residential and commercial sales offices and business locations.
- c. In no instance shall the corporate logo flag square footage area exceed that of the government flag with which it is flown.
- d. Corporate flags shall be counted against total maximum square footage allowed.

Awning signs

An "awning sign" is any awning containing signage used to identify a business, profession, service product or activity conducted, sold or offered on the premises where such sign is located. Awning signs are considered wall signs for the purpose of determining maximum wall sign coverage.

- a. Awning Signs shall be permitted only in the Town Center and COI Neighborhood Use Areas.
- b. The copy/artwork on an awning sign shall not exceed the area and size that is allowed for a wall sign on the wall to which it is attached. The copy area of the awning sign must be less than twenty-five percent (25%) of the awning.

Projecting Signs

A "projecting sign" is any sign, other than an awning, which projects perpendicular to a building and which is attached to a building or other permanent structure. Projecting signs are permitted only in the Town Center zoned area.

- a. The horizontal portion of any projecting sign shall not be more than six (6) feet and six (6) inches in length, measured from the building face.
- b. The projecting sign area shall not exceed six (6) square feet.
- c. Projecting signs, other than awning or canopy signs, shall be allowed over pedestrian sidewalks, walkways and corridors, with the following restrictions:

<u>Vertical Clearance</u>	<u>Maximum Projection</u>
7 feet or less	3 inches
7 or 8 feet	12 inches
8 feet or more	4 feet

Sign Types Not Specifically Addressed in Sign Code

Directional Signs

A “Directional Sign” is any sign, which directs the public to various locations, for instance, but not limited to, the retail, apartments, hotel or parking areas.

- a. Directional signage affixed to a building or other structure shall not exceed a maximum sign area of six (6) square feet.
- b. Directional signage setbacks shall be a minimum of five (5) feet.
- c. Directional signs may be located on collector and arterial roadways.
- d. A free standing Directional Sign shall not exceed a maximum area of fifteen (15) square feet. The width of a free standing directional sign shall not exceed three (3) feet wide, as measured perpendicular from the vertical.

Entrance Gateways

An “Entrance Gateway” is an entry feature, which may be freestanding, span across an area or attach to a building or structure. This feature identifies the entrance of a particular area. Such features are subject to review and approval by the Town at the time of Final PD Site Plan.

- a. Pedestrian Entrance Gateways which span across a public right-of-way to designate entrances to parks, trails, plazas, neighborhoods or other such areas, may be erected subject to Town of Castle Rock building codes pertaining to clearances, encroachments, etc.
- b. Vehicular Entrance Gateways, which span across the public right-of-way, are permitted only in the Town Center zoned area and are subject to approval of a Right-of-Way Encroachment Permit.

Directory Map

A “directory map” is a map listing the occupants within a shopping center, industrial sites, retail districts, residential sales offices, office districts, commercial sites, district and other community facilities.

- a. A directory map may be freestanding, mounted to a wall, or mounted to a vertical support.
- b. A directory map is used to provide wayfinding information.
- c. A directory map may be located on collector and arterial roadways, if posted within a designated pullout area outside of traffic flow.
- d. A directory map may be installed immediately adjacent to the property line (no setback) as long as it does not project over the plane of the property line.
- e. A directory map, mounted to a vertical support, shall not exceed twenty-four (24) square feet.
- f. No Directory Map Signage may encroach into the public right-of-way.

Additional Provisions

Streetscape Banners

The primary purpose of the Banner Program is to enhance the streetscape and feature community activities, institutions, milestones or historical events that reinforce the character and identity of The Meadows.

Banners will promote institutions and events contributing to the public good and benefit the cultural life of The Meadows and Castle Rock. Banners may be permitted only in the Town Center, and COI Neighborhood Use Areas. Banners may not be used for advertising a specific product or corporate entity. Banners may be proposed and sponsored by for-profit and non-profit entities, corporations and individuals provided they meet the following criteria for content and objectives.

In the event a designated Committee of the Home and Business Owners Association desires to own and maintain banner installation hardware, then the Committee will oversee banner content, programming, dismantle and maintenance on behalf of The Meadows.

- a. Banners are to be made from approved fabric only, and must be resistant to fading and tearing. Recommended fabrics include acrylic fiber canvas or rip-stop nylon.
- b. Banners shall be a maximum of 32" wide by a maximum of 80" long
- c. Banners are to be mounted on existing street light poles via horizontal supports at the top and bottom. The bottom of the banner is to be not less than 8'-0" above grade and must not encroach over roadway.
- d. Banners may display graphics and/or messages based on the criteria described in this document and on general aesthetic and suitability standards.
- e. Banners may be mounted to a vertical support, attached to a building or parking deck and, only in the case of Market Street of the Town Center, span the street.
- f. Banners, which are mounted to a vertical support, may be integrated onto street and pedestrian light poles, with the approval of the owner of the vertical support.

A-Frame Signs

An "A-Frame" Sign is a double-faced, movable, self-supporting sign that is normally placed in public view during business hours. A-Frame Signs are permitted only in the Town Center zoned areas.

- a. A-Frame Signs may be located in pedestrian areas without obstructing the public right-of-way provided that the sidewalk is at least ten (10) feet wide and the sign is located so as to not pose a danger to, impede or hinder pedestrian traffic.
- b. A-Frame Signs shall have a character of permanence by utilizing long lasting construction and materials.
- c. A-Frame Signs shall measure 2½' wide by 3½' high (30"x42") and cannot exceed a maximum sign area of 8.75 square feet per sign face or forty-two (42) inches in height.

Plaza Directional Signs

Installations of plaza directional signs for use in identifying the closest entrance to a neighborhood/village or facility shall comply with The Town of Castle Rock Sign Plaza Program in accordance with the approved permit specifications.

UNOFFICIAL COPY

EXHIBIT B

TOWN CENTER STREETS

UNOFFICIAL

COPY

UNOFFICIAL COPY

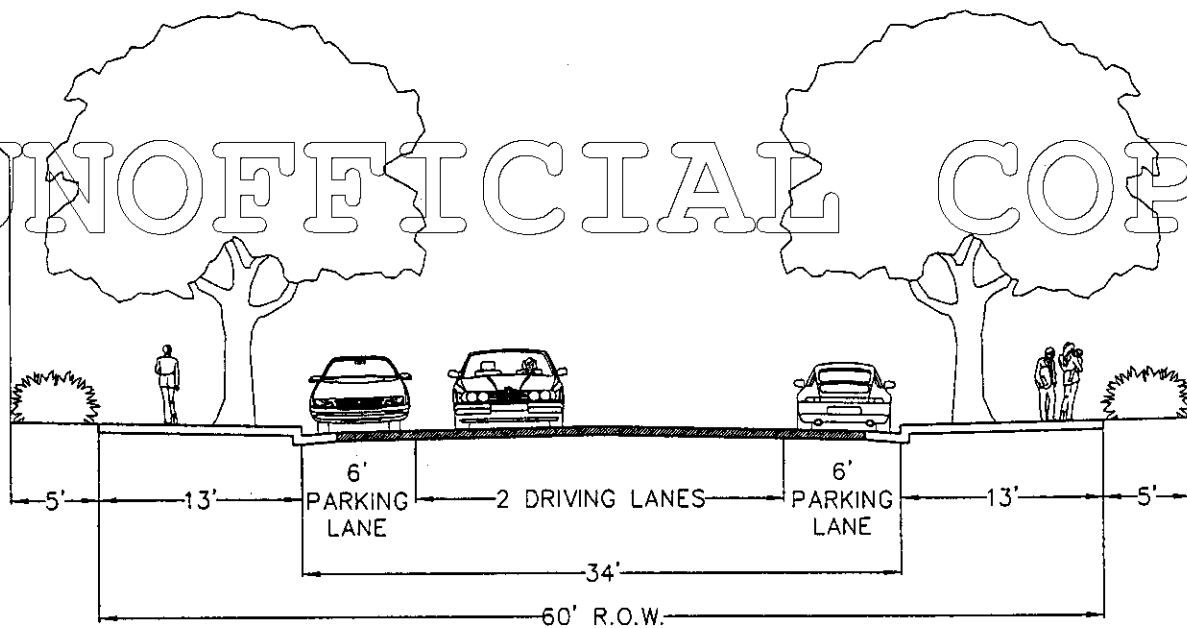

60' R.O.W.
2 DRIVING LANES
2 PARALLEL PARKING LANES
8' MINIMUM SIDEWALKS

TOWN CENTER
LOCAL COLLECTOR



TETRA TECH RMC, Inc.
8301 E. Prentice Ave., Suite 101, Greenwood Village, CO, 80111
TEL 303.741.6000 FAX 303.741.8108

UNOFFICIAL COPY

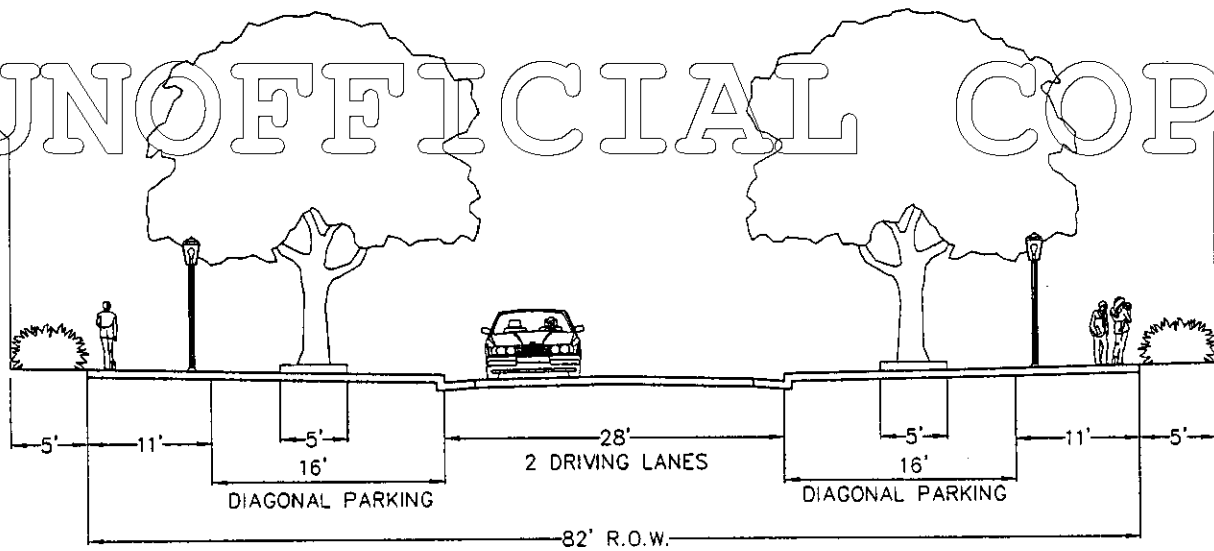

82' R.O.W.
2 DRIVING LANES
2 DIAGONAL PARKING LANES
11' MINIMUM SIDEWALKS

TOWN CENTER
MARKET STREET



TETRA TECH RMC, Inc.

8301 E. Prentice Ave., Suite 101, Greenwood Village, CO. 80111
TEL 303.741.5000 FAX 303.741.8108

UNOFFICIAL COPY

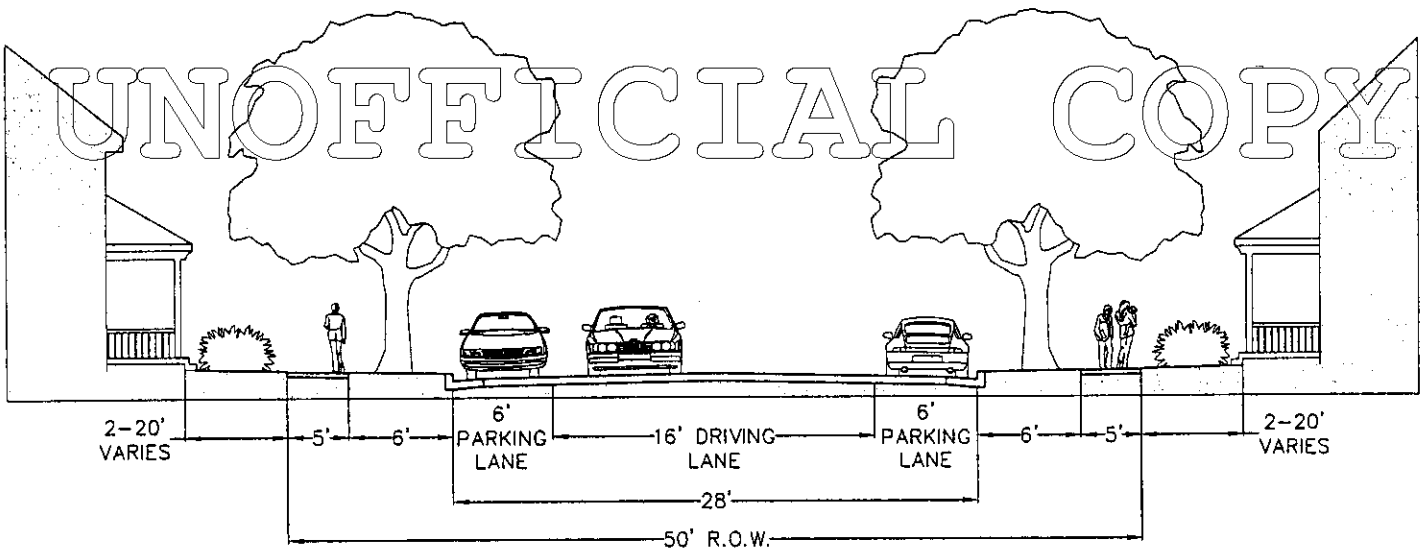

TOWN CENTER
STREET TYPE "B"



TETRA TECH RMC, Inc.

8301 E. Prentice Ave., Suite 101, Greenwood Village, CO. 80111
TEL 303.741.6000 FAX 303.741.6106

UNOFFICIAL COPY

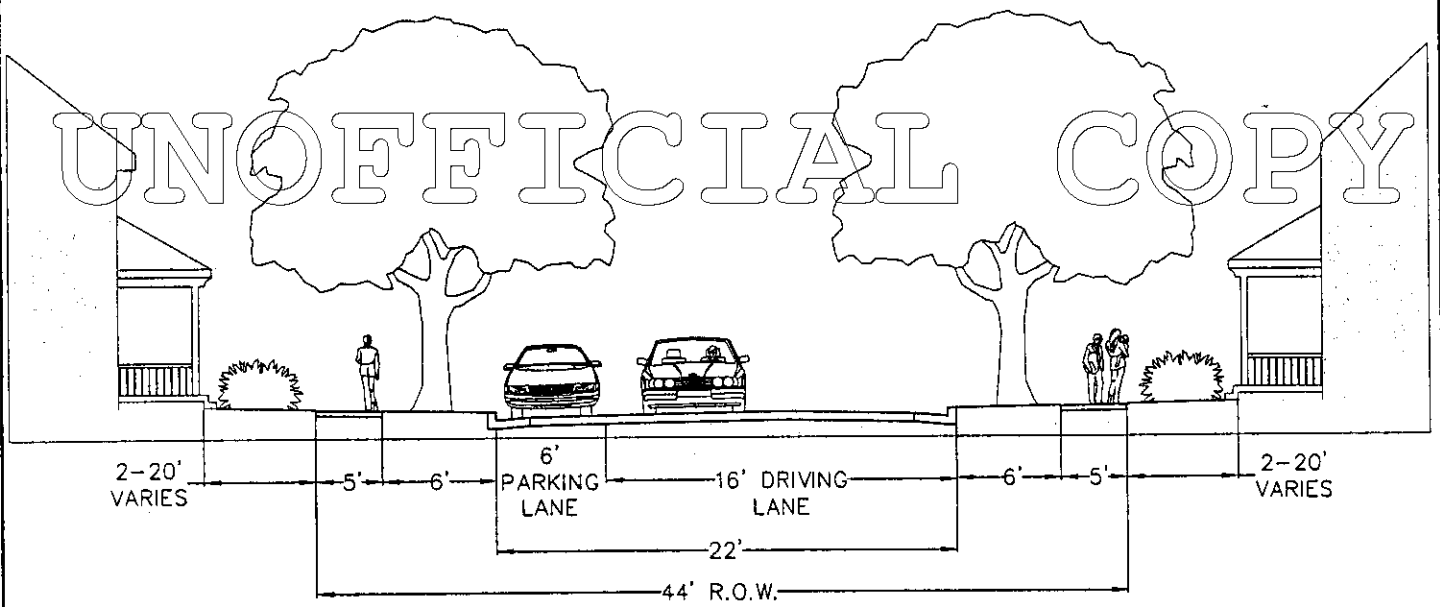

TOWN CENTER
STREET TYPE "D"



TETRA TECH RMC, Inc.

8301 E. Prentice Ave., Suite 101, Greenwood Village, CO, 80111
TEL 303.741.6000 FAX 303.741.6108

UNOFFICIAL COPY

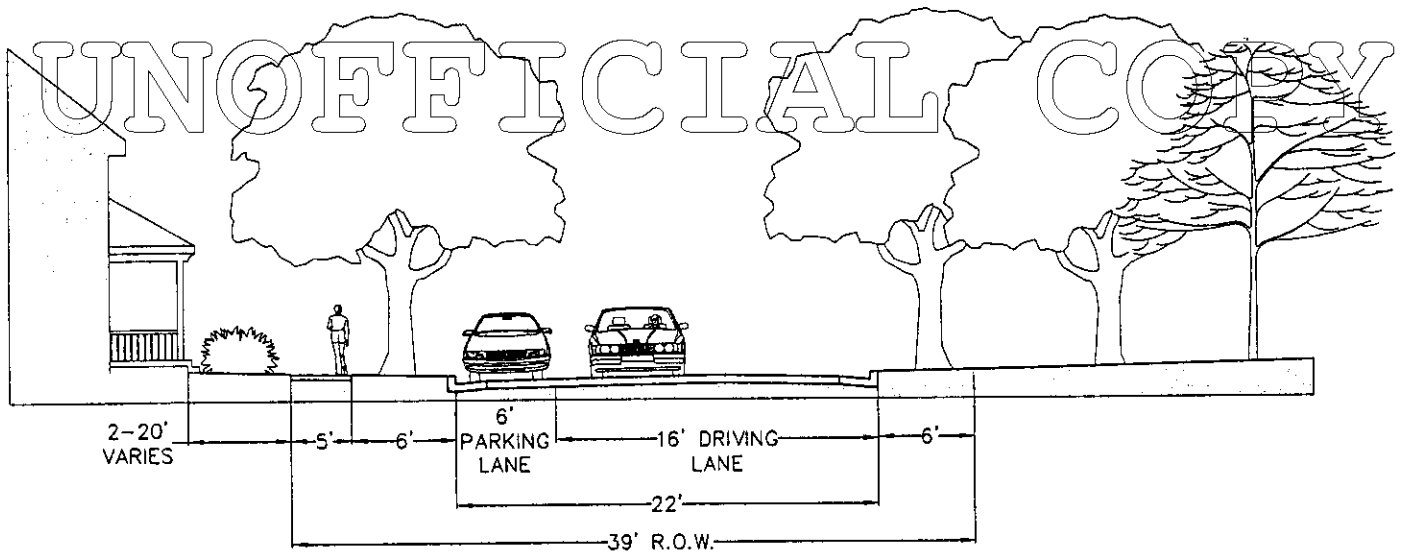

TOWN CENTER
STREET TYPE "E"



TETRA TECH RMC, Inc.

8301 E. Prantice Ave., Suite 101, Greenwood Village, CO, 80111
TEL 303.741.6000 FAX 303.741.6108

UNOFFICIAL COPY

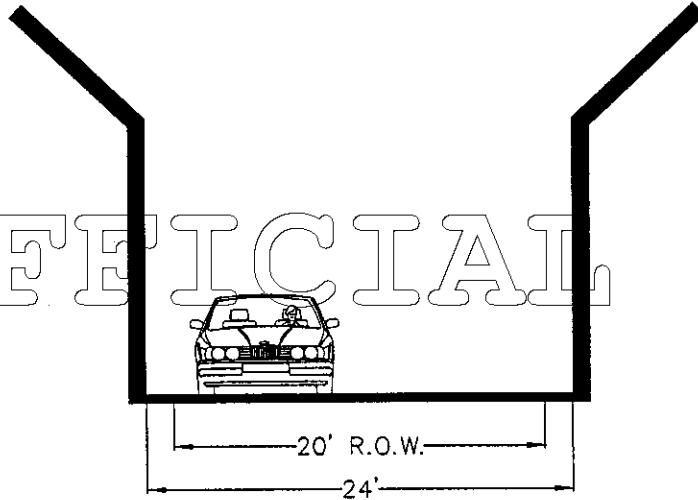

20' R.O.W.
24' BUILDING TO
BUILDING SETBACK

TOWN CENTER ALLEY'S



TETRA TECH RMC, Inc.

8301 E. Prentice Ave., Suite 101, Greenwood Village, CO, 80111
TEL 303.741.6000 FAX 303.741.6108

UNOFFICIAL COPY

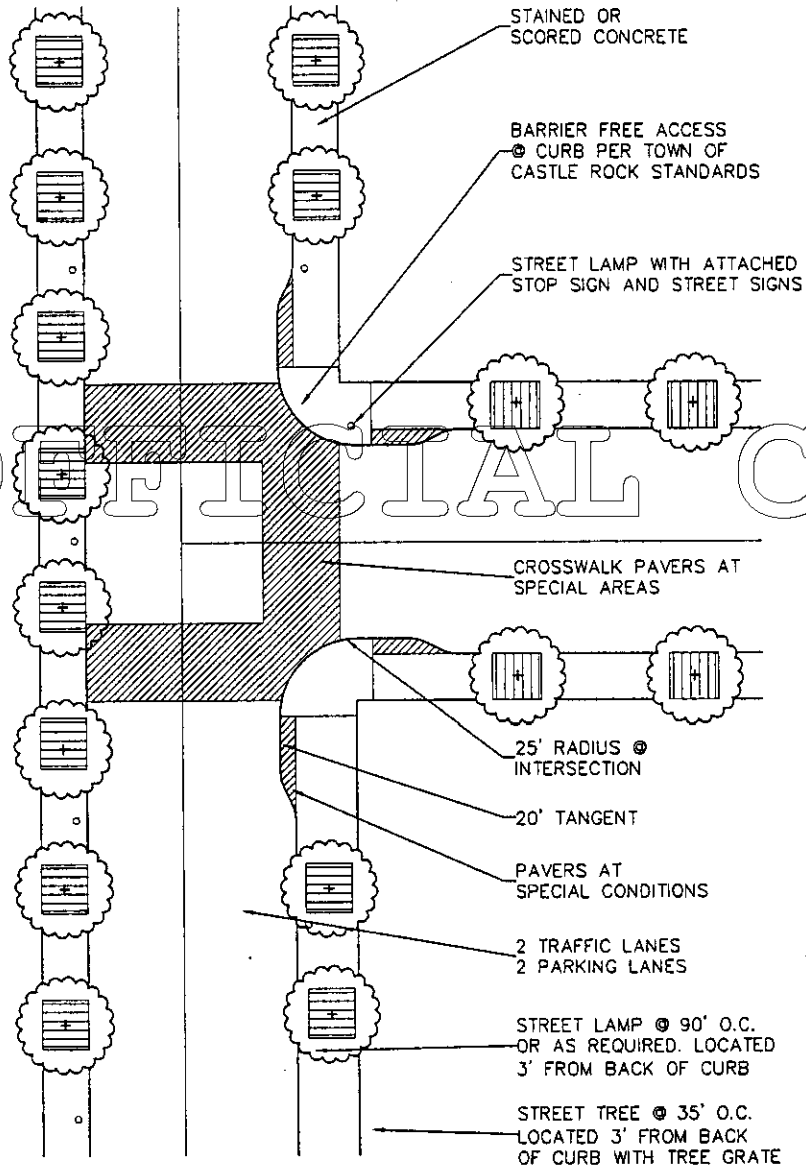

TOWN CENTER THREE WAY INTERSECTION WITH NECKDOWNS



TETRA TECH RMC, Inc.

8301 E. Prentice Ave., Suite 101, Greenwood Village, CO. 80111
TEL 303.741.6000 FAX 303.741.8106

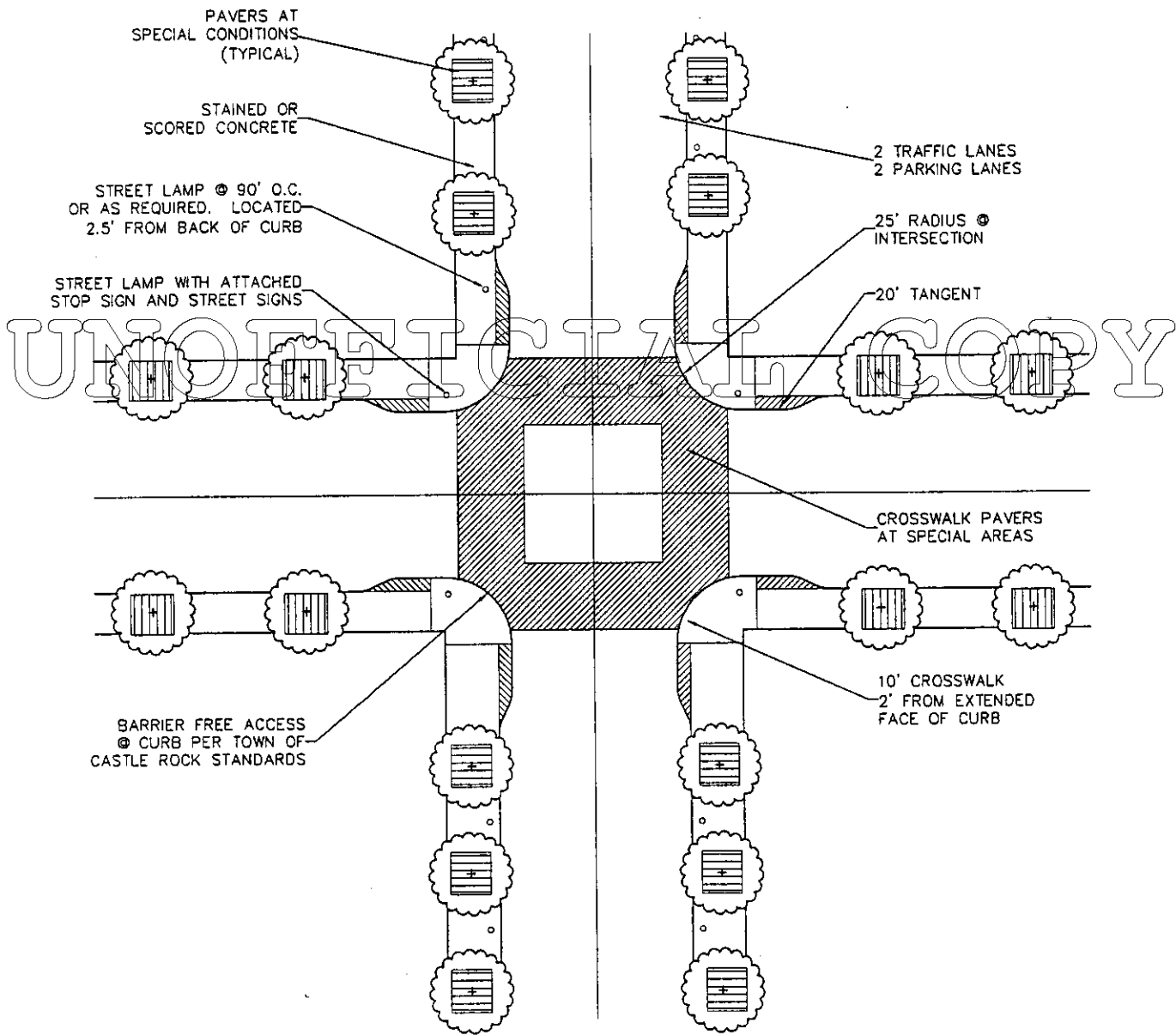

TOWN CENTER
FOUR WAY INTERSECTION

UNOFFICIAL EXHIBIT C TOWN CENTER LANDSCAPING COPY

UNOFFICIAL COPY

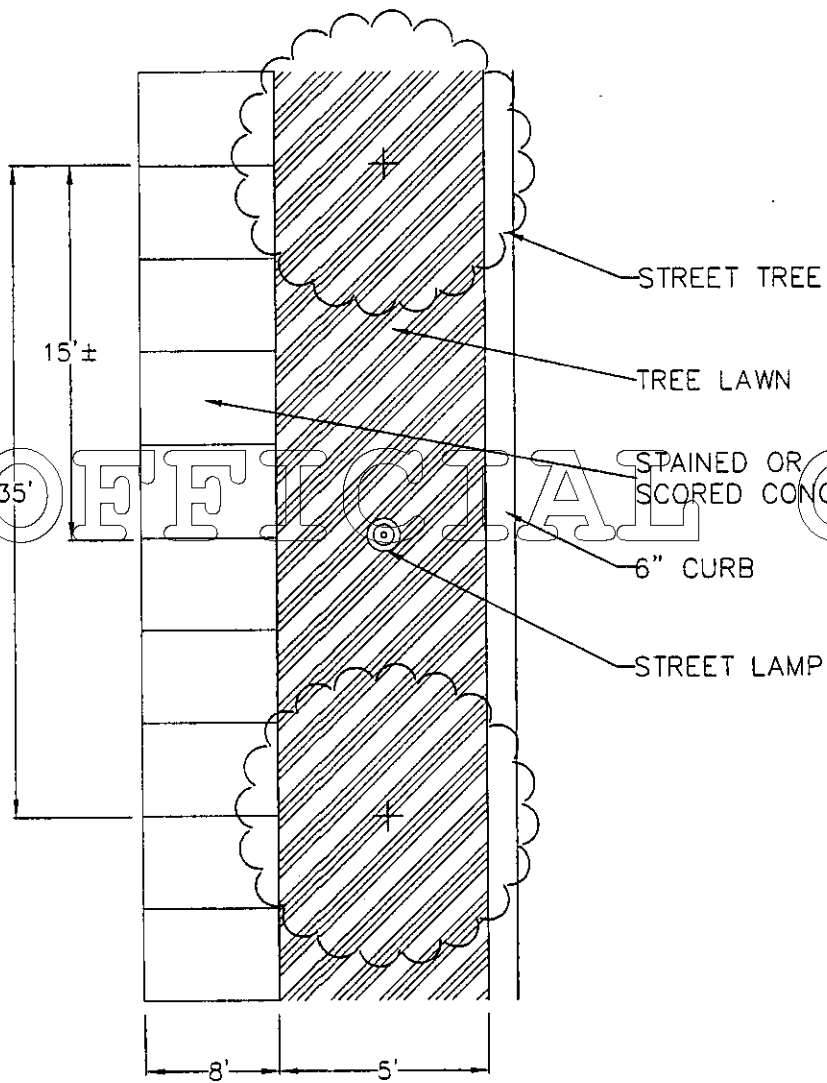

TOWN CENTER TYPICAL SIDEWALK TREATMENT AT LOCAL COLLECTOR



TETRA TECH RMC, Inc.

8301 E. Prentice Ave., Suite 101, Greenwood Village, CO. 80111
TEL 303.741.6000 FAX 303.741.6106

UNOFFICIAL COPY

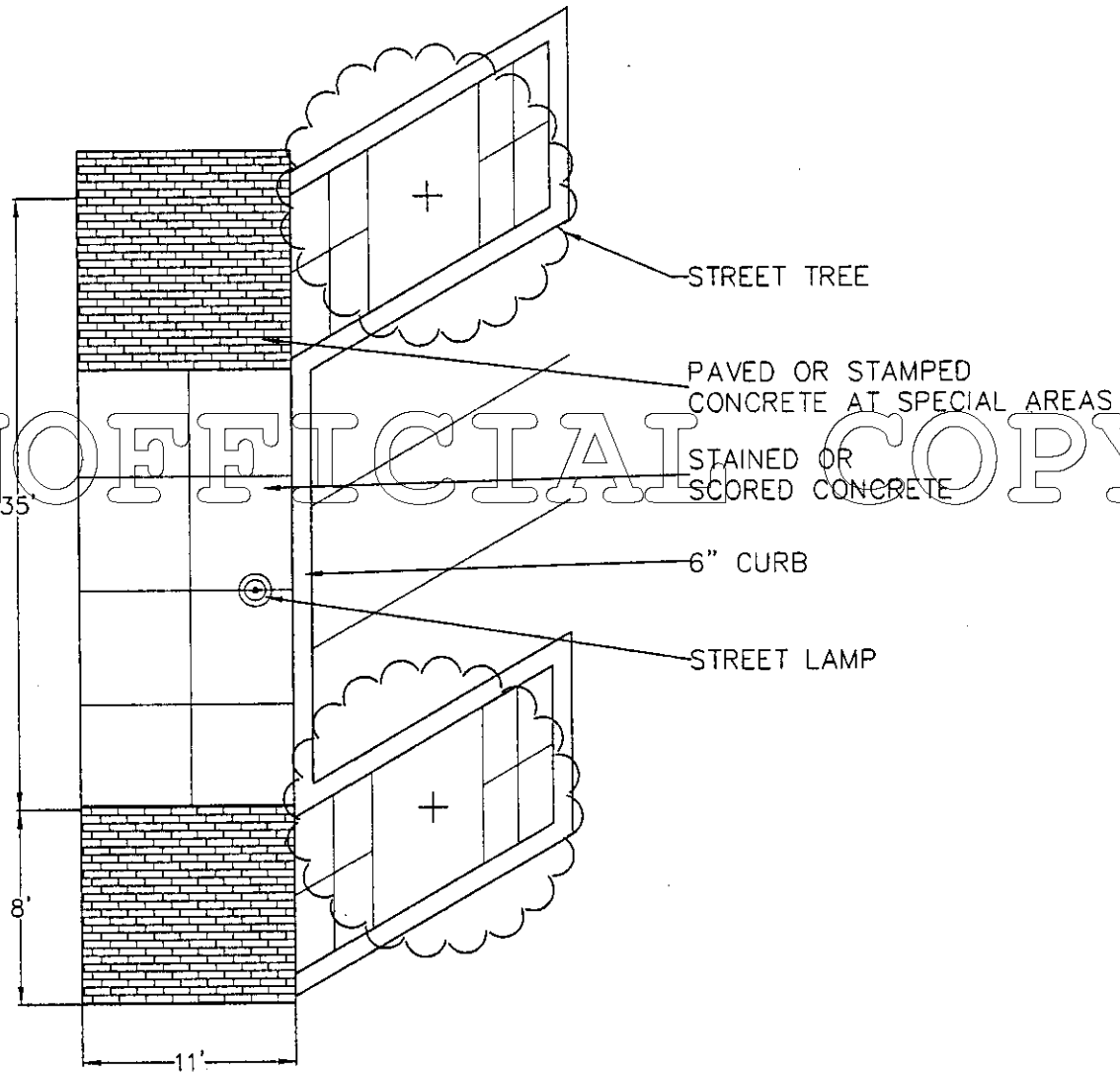

TOWN CENTER SIDEWALK
TREATMENT AT MARKET STREET



TETRA TECH RMC, Inc.

8301 E. Prentice Ave., Suite 101, Greenwood Village, CO. 80111
TEL 303.741.6000 FAX 303.741.8108

UNOFFICIAL COPY

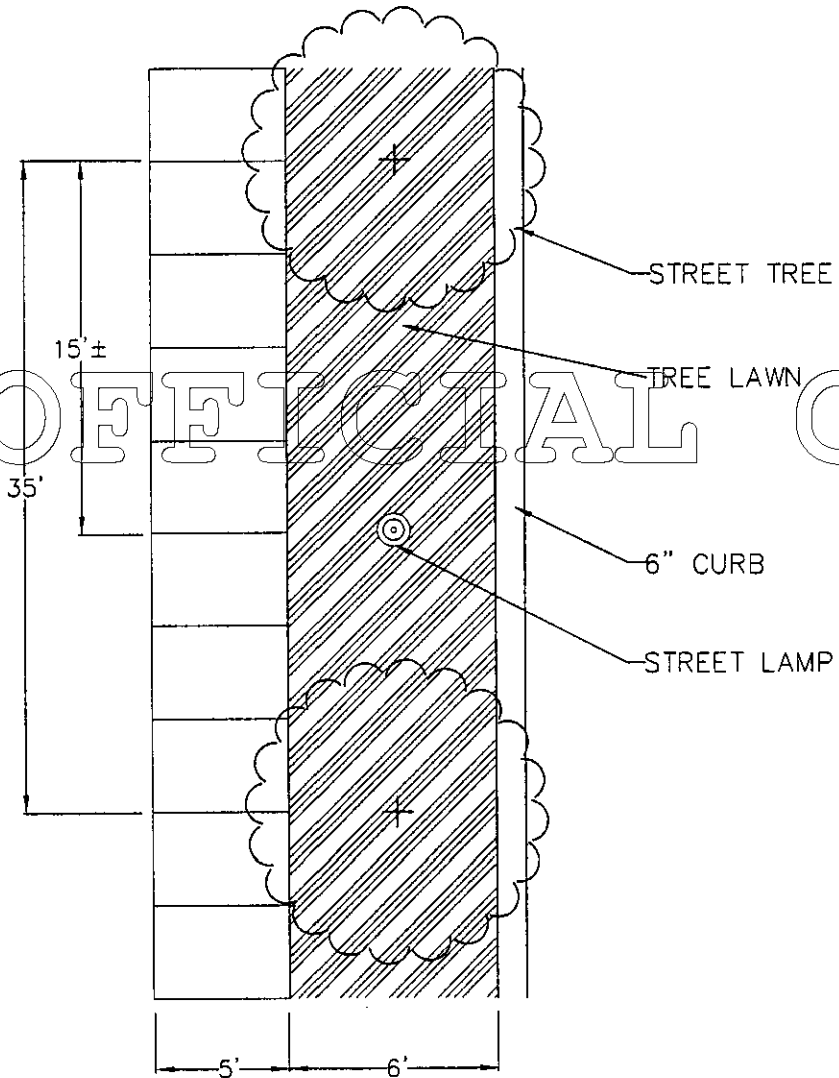

TOWN CENTER TYPICAL
SIDEWALK AT RESIDENTIAL STREETS



TETRA TECH RMC, Inc.
8301 E. Prentice Ave., Suite 101, Greenwood Village, CO. 80111
TEL 303.741.8000 FAX 303.741.8108